

M1 Garand Operation, Safety, and Maintenance Guide

for

Veteran and Civilian Service Organizations, Law Enforcement, and National Cemeteries

21 January 2020 – Change 4

Prepared by
Combat Capabilities Development Command Armaments Center
(CCDC-AC) Picatinny Arsenal, NJ 07806-5000



DISTRIBUTION STATEMENT A. Approved for public release: distribution is unlimited.

DISCLAIMER STATEMENT

This guide is intended to support the safe operation and maintenance of the M1 Garand Service Rifle and .30 Caliber M1909 Blank Ammunition being used by Veteran and Civilian Service Organizations, Law Enforcement, and National Cemetery Personnel approved to receive both M1 Garand Rifles and .30 Caliber Blank Ammunition from the U.S. Government. It is not intended as a guide for the general public. While the Combat Capabilities Development Command Armaments Center strives to make the information contained in this guide as accurate as possible, CCDC-AC makes no claims, promises, or guarantees about the accuracy, completeness, or adequacy of the contents of this guide, and expressly disclaims any liability for errors and omissions pertaining to its contents. No warranty of any kind, implied, expressed, or statutory is given with respect to the contents of this guide or any links to internet resources contained herein. References in this guide to any specific commercial product, process, or service, or the use of any trade, firm, or corporation name is for information purposes only and does not constitute endorsement, recommendation, or favoring by the Combat Capabilities Development Command Armaments Center or the United States Government.

Table of Contents

1.0 Introduction.....	6
1.1 Purpose and Scope	6
1.2 Importance of this Guide	7
1.3 General Description of the Rifle.....	7
2.0 Mechanical Training.....	7
2.1 Required Tools.....	7
2.2 Disassembly and Assembly Overview.....	7
2.3 Unloading and Clearing the Rifle	8
2.4 Disassembly into Three Main Groups	10
2.5 Barrel and Receiver Group – Disassembly of the Operating Mechanism	12
2.6 Barrel and Receiver Group – Assembly of the Operating Mechanism	19
2.7 Assembly of the Three Main Groups.....	29
2.8 Blank Firing Adapter (BFA).....	30
2.9 Test for Correct Assembly	30
3.0 Operation and Functioning.....	30
3.1 Loading Rounds into a Clip	30
3.2 Loading the Rifle	31
3.3 Unloading the Rifle (not due to a misfire).....	32
3.4 Functioning of the Rifle	32
4.0 Stoppage, Immediate Action, Malfunctions, and Ammunition Malfunction Reporting.....	34
4.1 Immediate Action	34
4.2 Malfunctions	34
4.3 Ammunition Malfunction Reporting	37

5.0 Maintenance	37
5.1 Cleaning Materials, Lubricants, Equipment, and Parts	37
5.1.1 Cleaning Solutions	37
5.1.2 Lubricants	37
5.1.3 Equipment	38
5.2 Cleaning the Rifle	38
5.2.1 Chamber	38
5.2.2 Bore	39
5.2.3 Gas Cylinder Lock Screw Assembly	39
5.2.4 Piston Operating Rod	39
5.2.5 Gas Cylinder	39
5.2.6 Face of the Bolt	39
5.2.7 Rifle Stock	39
5.2.8 All Other Parts	40
5.3 Routine Maintenance	40
5.3.1 Daily Inspection	40
5.4 Blank Firing Adapter/Barrel Inspection Criteria	40
5.4.1 BFA Inspection	40
5.4.2 Barrel Thread Inspection	44
6.0 Ceremony Planning and Safety Guidance	47
6.1 Ceremony Planning	47
6.2 Hearing Protection	48
6.3 Standoff Distance	48
6.4 Expended Brass	48
7.0 Ammunition	48
7.1 Ammunition Safety Warnings	48
7.2 Ordering Ammunition	49
7.3 Authorized Ammunition	50
8.0 Physical Security and Inventory Requirements	51

8.1 Rifle and Ammunition– Physical Security and Inventory Requirements	51
9.0 Comments, Questions, and Suggestions.....	52
Appendix A: Safety Area Template	53
Appendix B: Ceremonial Rifle Inventory Form	54

1.0 Introduction

1.1 Purpose and Scope

Although the M1 Garand Rifle is no longer actively used by the U.S. Military, Public Law 106-65 (10 USC 7683) allows for the conditional donation by the U.S. Government of .30 Caliber M1 Garand Rifles to eligible organizations for use by those organizations in the rendering of funeral honors for a member or former member of the U.S. Armed Forces and for general ceremonial purposes. The M1 Garand is currently the only ceremonial rifle being conditionally donated. The number of conditionally donated ceremonial rifles (both bolt-action and the M1 Garand) in possession by any eligible organization cannot exceed 15 (fifteen). Rifles in excess of 15 must be turned in. The replacement or exchange of ceremonial rifles is authorized on a one-for-one basis if the ceremonial rifle becomes unserviceable. Ceremonial rifles remain the property of the United States Government. The recipient organization is not authorized to use the rifle as security for any loan, nor sell, lease, rent, or exchange the property for monetary gain or for any other purpose. Nor is the recipient organization authorized to transfer, relocate, or dispose of the asset without written approval from the Army Donations Program Office.

The storage of the ceremonial rifles is at the discretion of your organization as long as you comply with local, state, and federal guidelines for firearms.

The Ceremonial Rifle Form, which is the document organizations use for their required reporting to the US Army ceremonial rifles in their possession every three years, is included in Appendix B.

This document should be used as a guide by these nonmilitary organizations for the maintenance, operation, and general information relating to the M1 Garand Rifle. As with

any firearm, if any operation of the M1 Garand Rifle seems questionable or out of the ordinary, bring the weapon to a competent professional for servicing.

The Corporation for the Promotion of Rifle Practice and Firearms Safety, Inc. (CPRPFS):

The Corporation for the Promotion of Rifle Practice and Firearms Safety, Inc. (Civilian Marksmanship Program (CMP)) is the organization designated by the U.S. Government with providing weapon support, including parts replacement information, and weapon maintenance training to law enforcement, civilian and veteran service organizations, and national cemeteries that are furnished with M1 Garand Rifles. In addition, they assist with the reporting and onsite data collection for malfunctions. They can be contacted at: Civilian Marksmanship Program, 1401 Commerce Blvd., Anniston, AL 36207 Tel. 256-835-8455/Fax. 256-835-3527, www.thecmp.org.

In the event of an ammunition malfunction contact the U.S. Army Joint Munitions Command (JMC):

Ammunition Surveillance Division (AMSJM-QAS)
2695 Rodman Ave
Rock Island, Illinois 61299-6000
DSN 793-7295
COMM 309-782-7295
FAX 309-782-7136
usarmy.ria.jmc.mbx.amsjm-qas@mail.mil

Mailing Address:
U.S. Army Joint Munitions Command, AMSJM-QAS
2695 Rodman Ave, Rock Island, IL 61299-6000

For comments, suggestions, or questions concerning this guide contact the U.S. Combat Capabilities Development Command Armaments Center (CCDC-AC):

Telephone: 973-724-3056

Fax: 973-724-4633

E-mail: usarmy.ccdc-ac.pica2028@mail.mil

Website: <http://www.m1garandtraining.com>

Mailing Address:

U.S. Army CCDC-AC Attn: FCDD-ACE-LL

Picatiny Arsenal, NJ 07806-5000

Rifle Authorizations and Turn-In:

For recognized Veteran Service Organizations regarding issues concerning M1 Garand Rifle authorizations for new issue or for equipment turn in, please contact your organization's National Headquarters. Information concerning the U.S. Army Donations Program is also contained in your organization's officer's guide. For other organizations, such as law enforcement, contact the U.S. Army Donations Program Office located in Detroit Arsenal, MI at usarmy.detroit.tacom.mbx.ilsc-donations@mail.mil, (586) 282-9861.

Mailing Address:

US Army Tank-automotive and Armaments Command (TACOM)

ATTN: AMSTA-LCL-IWD, M/S 419D

6501 East 11 Mile Road

Detroit Arsenal, MI 48387-5000

1.2 Importance of this Guide

In order to minimize weapon failures and increase safety, it is important for each operator to know the working parts and proper operation and maintenance of the weapon. Procedures other than those described herein should not be performed without consulting CMP.

WARNING: Severe weapon damage and/or injury may occur if the weapon is not maintained and operated properly.

1.3 General Description of the Rifle

The U.S. Rifle Caliber .30, M1 Garand, is an air cooled, gas operated, en-bloc clip-fed, semiautomatic shoulder fired weapon. This means that air cools the barrel; that the power to cycle the action comes from gas pressure created by the firing of each round; that it is loaded by inserting a metal en-bloc clip into the receiver; and that the rifle fires one round each time the trigger is pulled.

2.0 Mechanical Training

2.1 Required Tools

- T-grip flathead screwdriver (preferred) or regular flathead screwdriver.
- 1/8-inch punch or similar object
- 7/16-inch wrench or adjustable wrench
- Wooden mallet

2.2 Disassembly and Assembly Overview

The rifle should be disassembled and assembled only when maintenance is required or for instructional purposes. Repeated disassembly and assembly causes excessive wear and tear of parts and increases the frequency of weapon failure/part replacement.

The rifle has been designed so that it may be disassembled and reassembled easily. With the exception of the bolt, the parts of one rifle may be interchanged with those of another rifle, when necessary. For safety reasons, bolts should never be interchanged except by designated representatives of CMP.

To make assembly easier, the parts should be laid out on a clean flat surface, from left to right, in the order of removal as the rifle is disassembled.

2.3 Unloading and Clearing the Rifle

The first step in handling any weapon is to unload and clear it. To unload a round from the chamber, support the rifle; with the right hand grasp the operating rod handle and pull the operating rod slowly to the rear (fig 1). At the same time, place the left hand, palm down, over the receiver to catch the round as it is ejected.



Figure 1. Pulling operating rod

To unload a clip, unload the round that is in the chamber as described above. When the operating rod reaches its rearmost position, hold it there. Place the palm of the left hand over the receiver and depress the clip latch (fig 2) with the left thumb, allowing the clip to be ejected up into the hand. Do not relax the rearward pressure on the operating rod handle until after the clip has been removed.

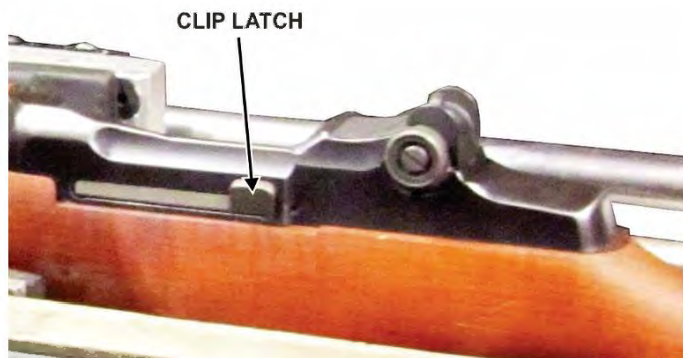

Figure 2. Clip latch

To clear the rifle, pull the operating rod handle all the way to the rear (make sure that the bolt is fully rearward and not caught on the follower assembly (figs 3 and 4)) and inspect the chamber and receiver to be sure that no rounds are present.

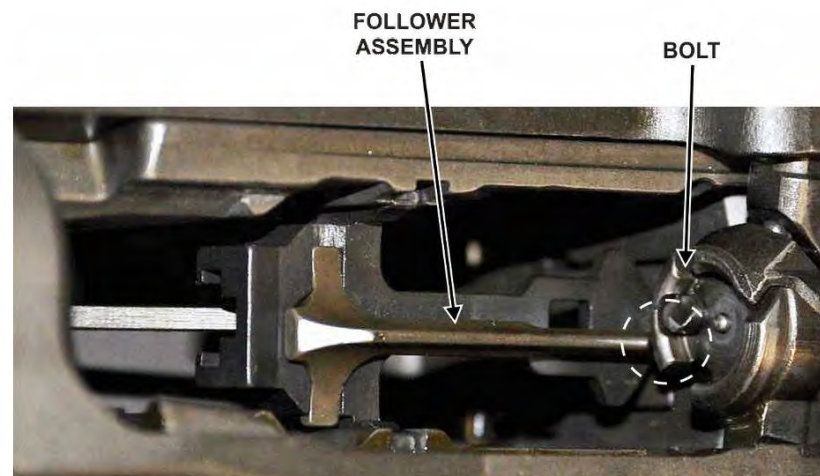

Figure 3. Bolt caught on follower assembly – INCORRECT

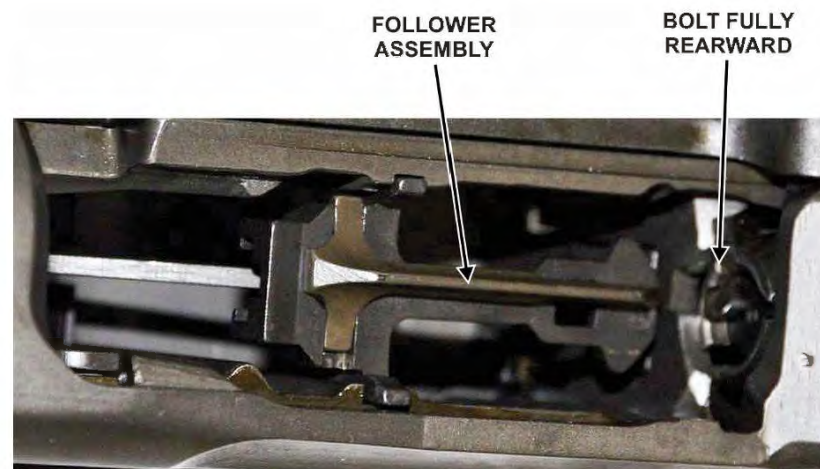

Figure 4. Bolt fully rearward – CORRECT

Push the safety rearward to its engaged position (inside the trigger guard) (fig 5 and 6). The M1 rifle is considered clear when there is no ammunition in the chamber or receiver, the bolt is locked to the rear, and the safety is engaged.

WARNING: The bolt of the M1 rifle can slam shut unexpectedly if the shooter does not strictly follow these instructions. If your thumb or finger is in its path, a painful condition/injury called “M1 Thumb” is a strong possibility.

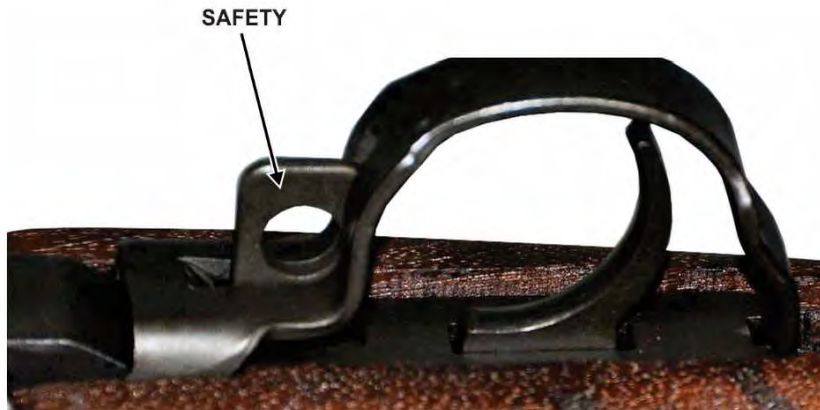

Figure 5. Safety is not engaged

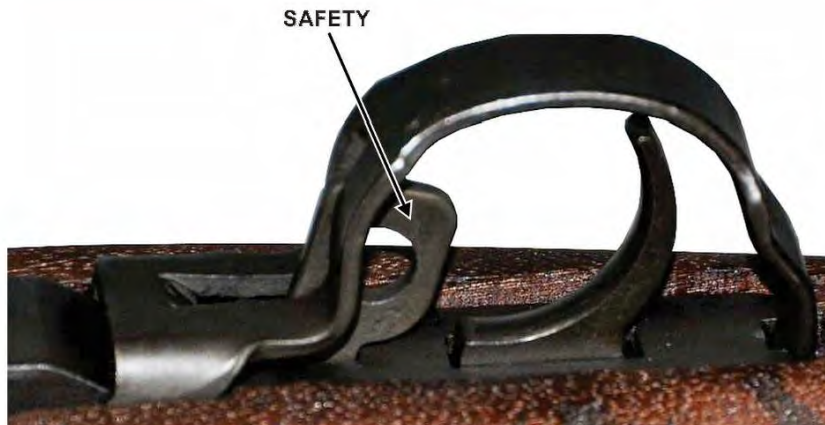

Figure 6. Safety is engaged

2.4 Disassembly into Three Main Groups

- 1) To disassemble the rifle into three main groups – trigger group, barrel and receiver group, and stock group (fig 7) – first make sure that the weapon is clear (fig 8) and then allow the bolt to go forward by depressing the follower assembly (fig 9) and allowing the bolt to ride forward over the follower assembly (see “M1 Thumb” WARNING in previous section).



Figure 7. Trigger group, barrel and receiver group, and stock group



Figure 8. Checking that weapon is clear



Figure 9. Depressing the follower assembly

- 2) Rotate the elevation knob so the rear sight is at its lowest position (fig 10). Invert the rifle and place it on a flat surface so that the trigger assembly is facing upward. While securing the rifle with one hand, pull rearward and upward on the trigger guard (fig 11 and 12). Lift straight up to remove the trigger housing assembly.

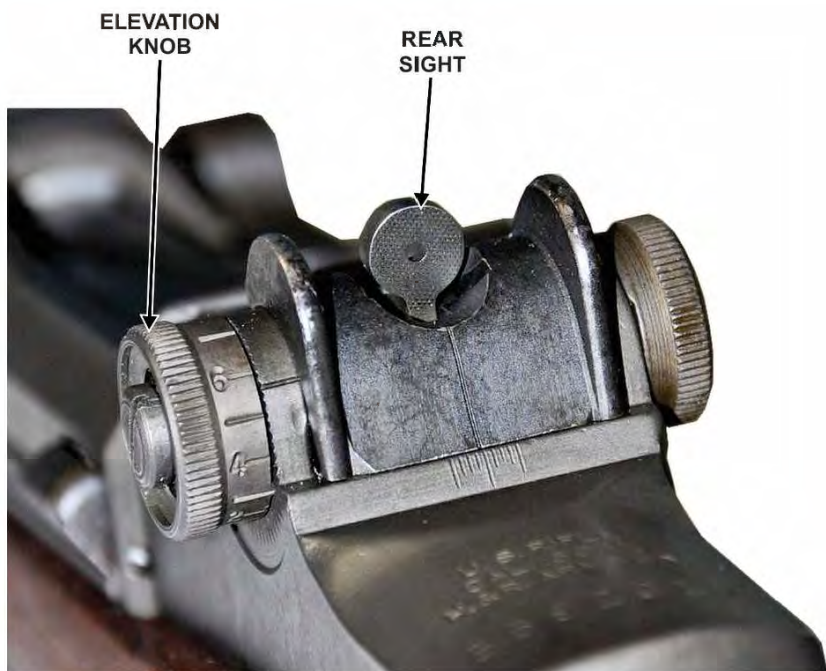

Figure 10. Elevation knob and rear sight



Figure 11. Trigger guard being pulled rearward and upward

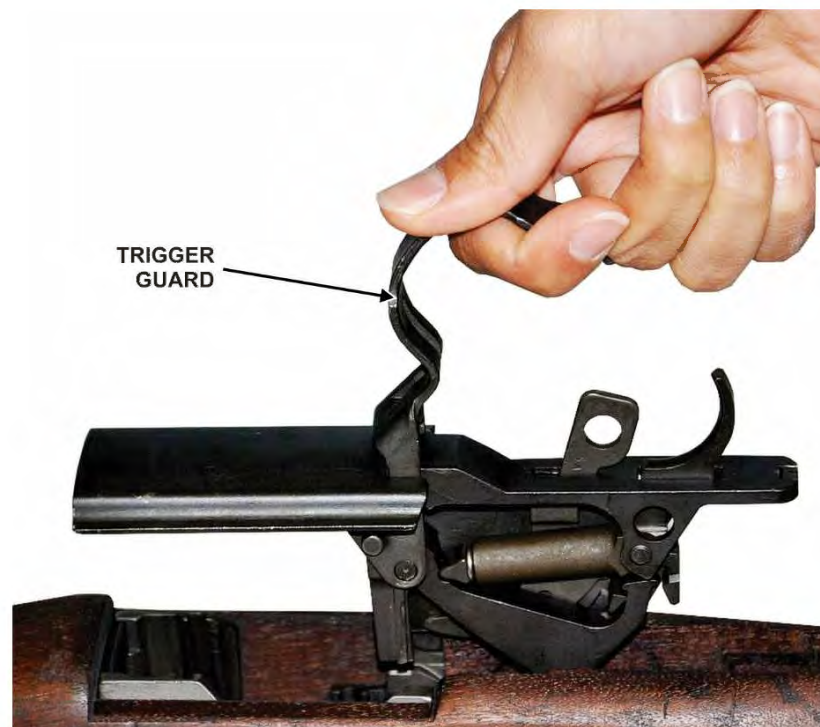

Figure 12 Trigger guard and housing assembly being pulled out of stock

- 3) Lift up on the stock to separate the stock from the barrel and receiver group. It may be necessary to slap the stock upward while holding the receiver (fig 13). Grasp the stock and rotate it up and off of the barrel and receiver group.



Figure 13. Lifting up stock

2.5 Barrel and Receiver Group – Disassembly of the Operating Mechanism

- 1) With the sights facing down, place the barrel and receiver group on a flat surface. Hold the rear of the receiver then grasp the follower rod. Disengage the follower rod from the follower arm by moving it toward the muzzle (fig 14), then slowly allow the operating rod spring to extend in a controlled fashion (fig 15). You may need to push down on the follower assembly (shown in fig 14) to disengage the follower rod from the follower arm. Remove the follower rod and operating rod spring from the barrel and receiver group. Do not separate these parts.

CAUTION: Maintain control of the follower rod/operating rod spring until completely removed.

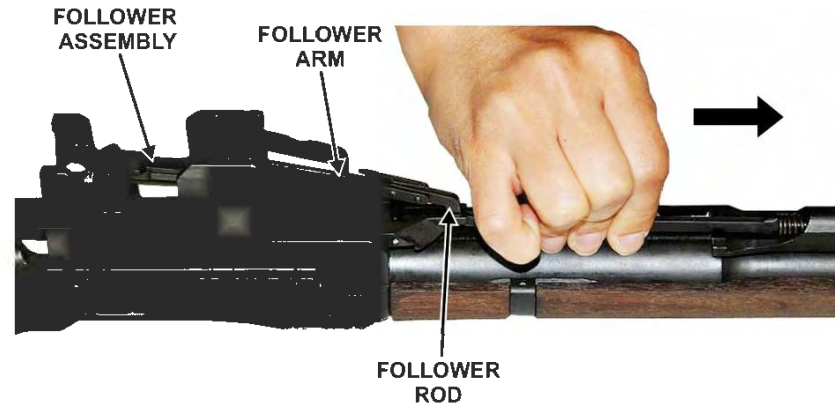

Figure 14. Follower rod being moved towards muzzle

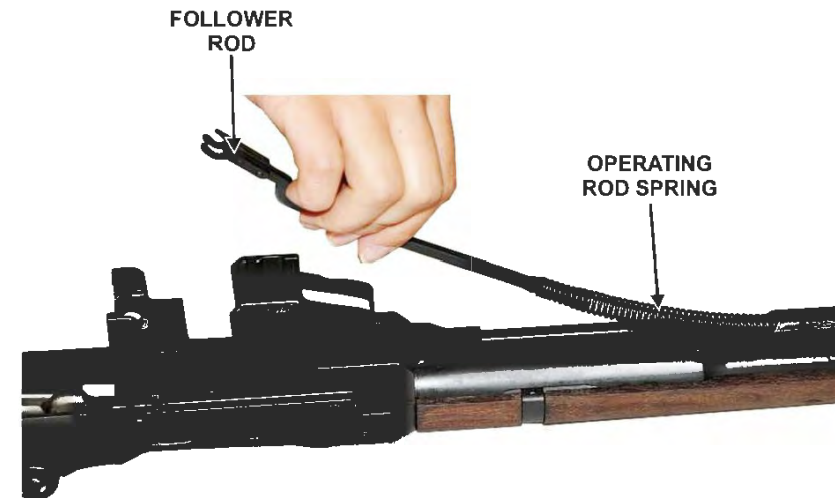

Figure 15. Extending operating rod spring in controlled fashion

- Using a 1/8 inch punch, remove the follower arm pin by pushing on it from the small side of the pin (the left side of the rifle when it is upright and pointed downrange). The large end of the pin can then be grasped and fully removed (fig 16).

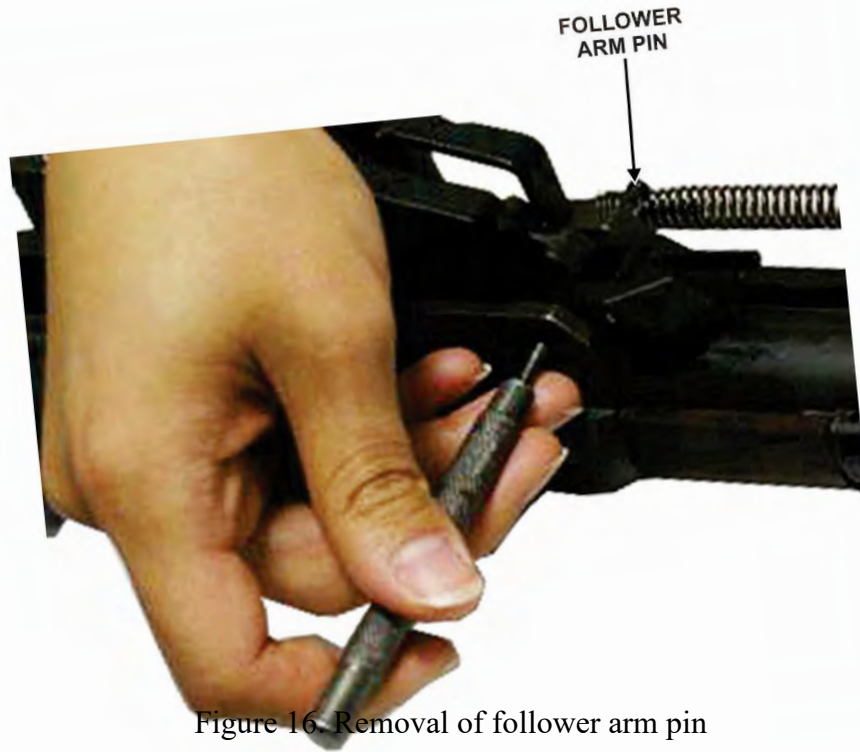

Figure 16. Removal of follower arm pin

- Grasp the bullet guide and follower arm and lift them out of the receiver (fig 17). Then lift the operating rod catch and lift it out of the receiver (fig 18).



Figure 17. Bullet guide and follower arm removal



Figure 18. Operating rod catch removal

- 4) Reach down into the receiver and lift the follower assembly (fig 19).

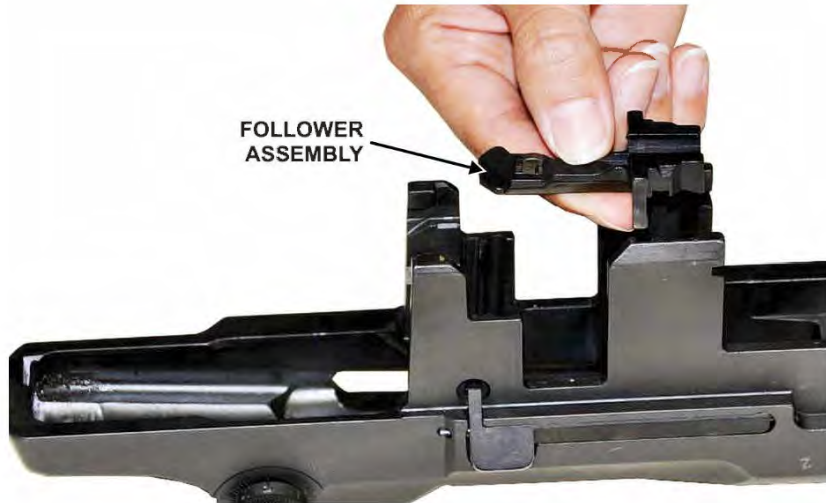

Figure 19. Follower assembly removal

- 5) With the receiver facing upright, pull the operating rod to the rear with slight upward force until it engages the notch (fig 20) in the receiver. The rear of the handle will be directly under the forward edge of the windage knob (fig 21).

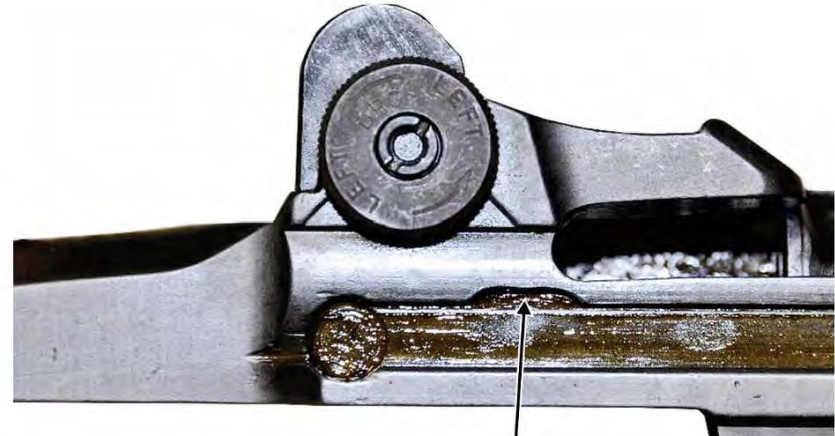

Figure 20. Notch on receiver

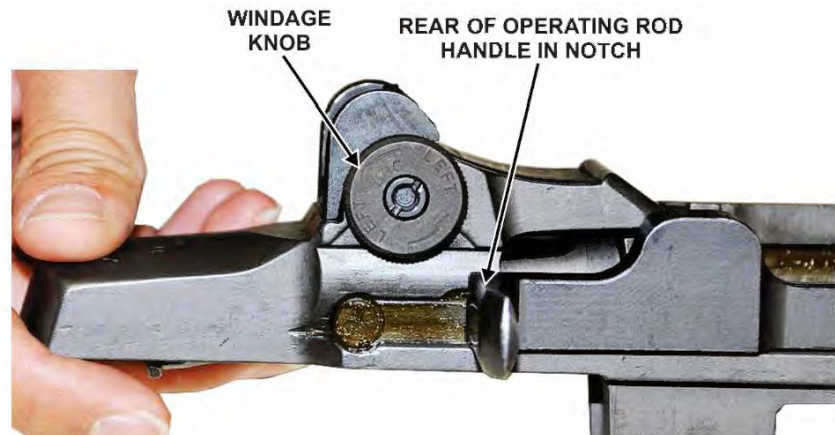

Figure 21. Handle under forward edge of windage knob

- 6) Apply upward force and then rotate the handle clockwise to separate it from the bolt lug (fig 22). You may need to jiggle the operating rod slightly to disengage it. Remove the operating rod.

CAUTION: The piston end of the operating rod is bent intentionally so that it will not bind against the enlarged portion of the barrel. Do not attempt to straighten it.

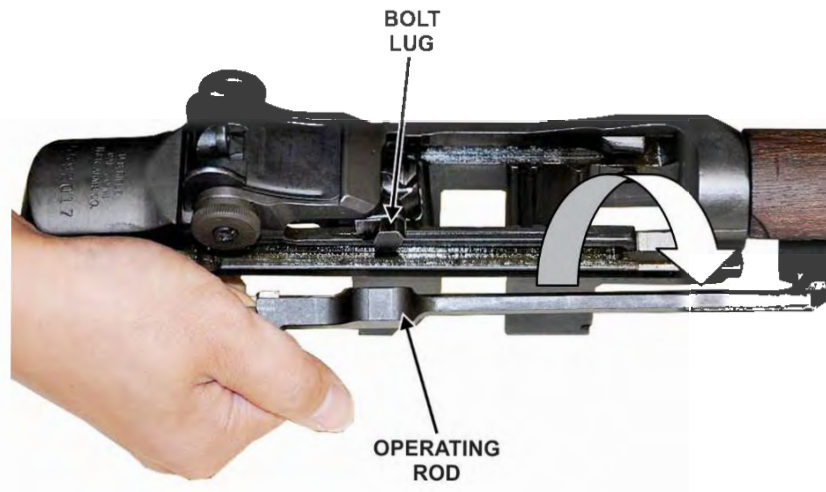

Figure 22. Operating rod removal

- 7) From the shooter's perspective, grasp the bolt on the exposed lug and slide the bolt forward while lifting it upward and outward with a rotating motion (fig 23).

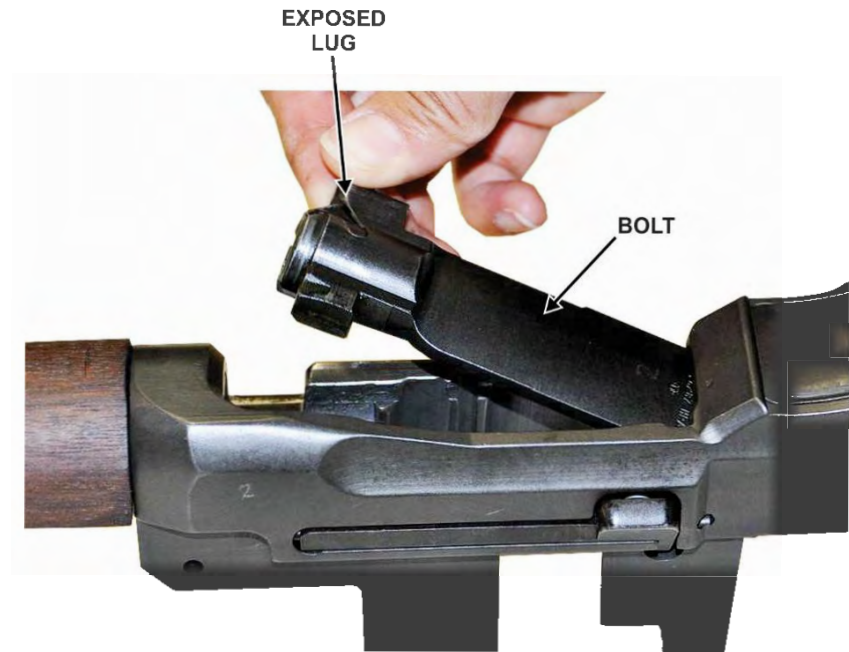

Figure 23. Bolt removal by exposed lug

- 8) Using a T-grip screwdriver (preferred), or a standard flathead screwdriver, unscrew and remove the gas cylinder lock screw and then unscrew the Blank Firing Adapter (BFA) (figs 24 and 25). If necessary, apply light pressure with 7/16-inch wrench to remove the BFA.

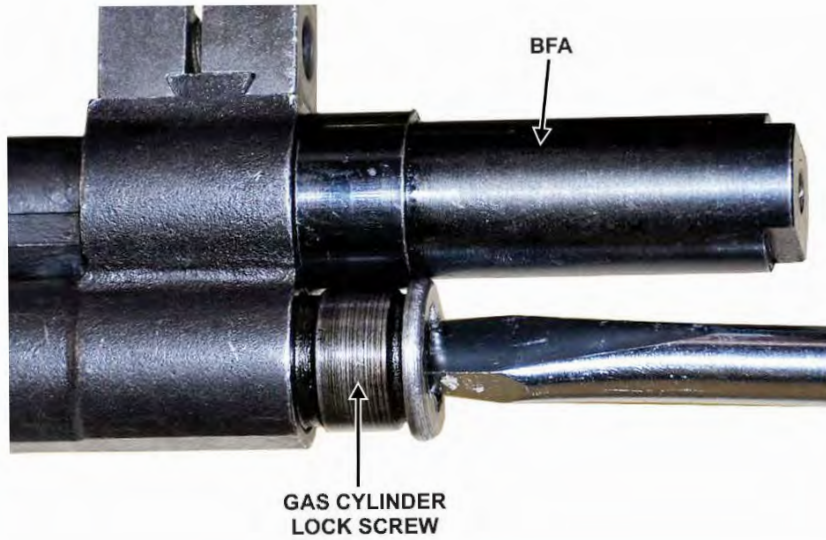

Figure 24. Gas cylinder lock screw removal



Figure 25. BFA removal

- 9) Loosen the gas cylinder by tapping lightly toward the muzzle on the bayonet lug with a wooden mallet or similar soft object (fig 26) and remove the gas cylinder (fig 27).

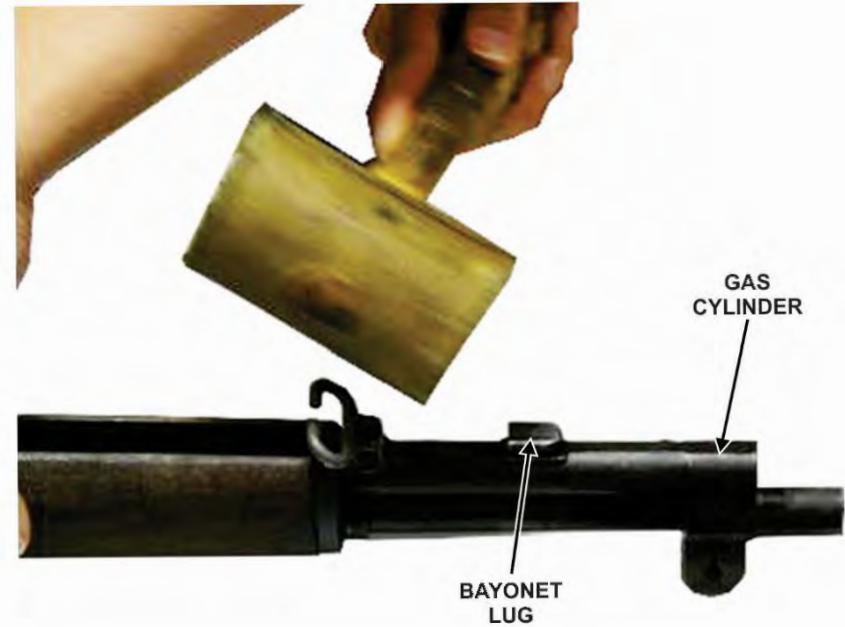

Figure 26. Loosen gas cylinder with wooden mallet

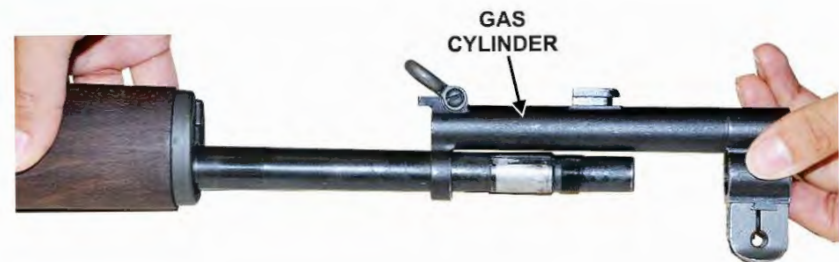

Figure 27. Gas cylinder removal

10) Remove the front handguard by sliding it forward over the muzzle (fig 28).

CAUTION: Do not attempt to remove the rear handguard.

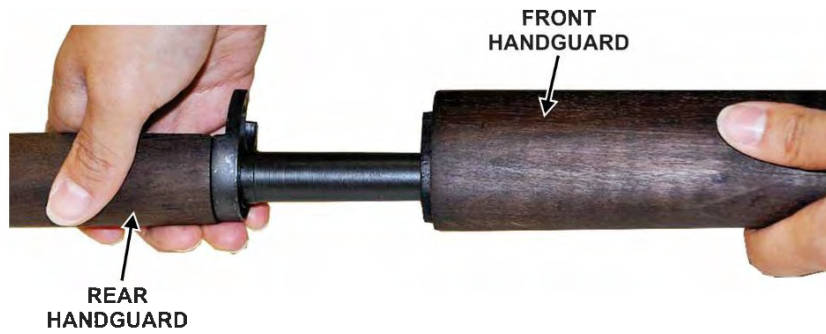

Figure 28. Removal of front handguard

11) The parts of the barrel and receiver group are shown below along with the stock group and trigger group (fig 29).



Figure 29. Disassembled parts of M1 Garand Rifle

2.6 Barrel and Receiver Group – Assembly of the Operating Mechanism

- 1) Replace the front hand guard by sliding it over the muzzle and ensuring that it is seated properly in the lower band (fig 30).



Figure 30. Front hand guard insertion

- 2) Place the gas cylinder over the barrel, making sure that the splines are aligned with their grooves (fig 31).



Figure 31. Splines & groove

- 3) Push the gas cylinder down until the forward edge is flush with the larger diameter portion of the barrel (figs 32 and 33).

NOTE: If necessary, a wooden mallet or similar tool may be used to tap the gas cylinder into place.

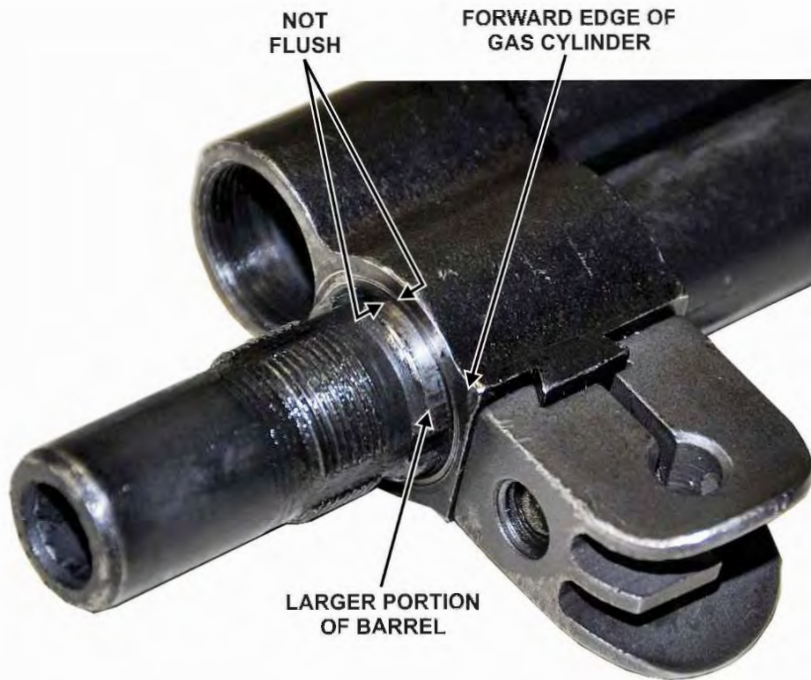

Figure 32. Gas cylinder positioned INCORRECTLY (too far rearward)

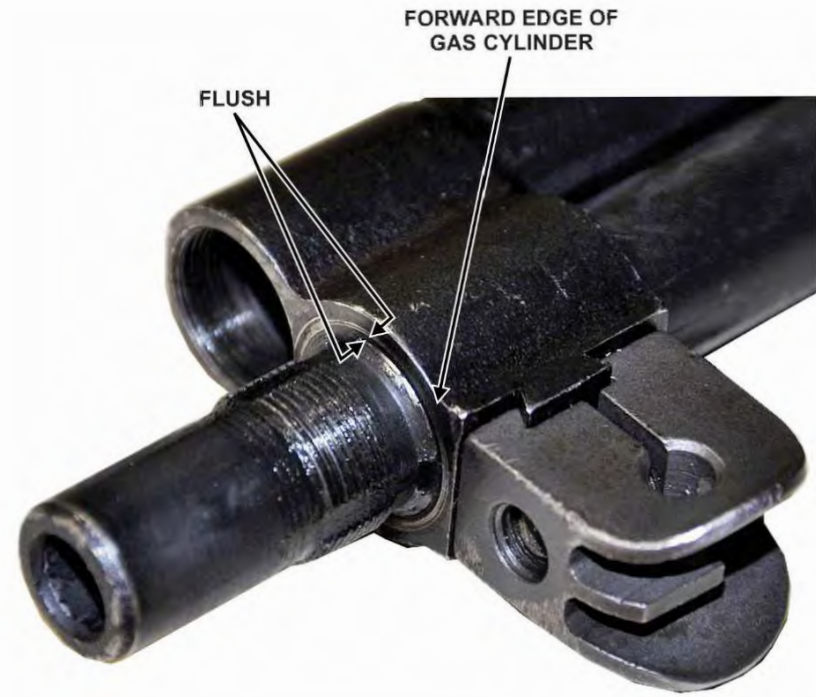

Figure 33. Gas cylinder positioned CORRECTLY

- 4) Screw the BFA onto the barrel until it touches the gas cylinder (fig 34).

WARNING: Once contact is made with the gas cylinder, do not tighten further.

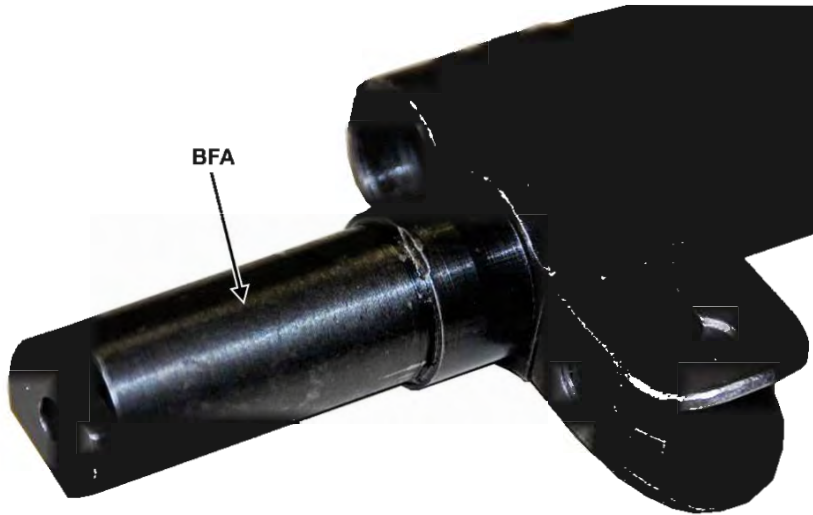

Figure 34. BFA installation

- 5) Attach the gas cylinder lock screw into the gas cylinder with a T-grip screwdriver (preferred) or a standard flathead screwdriver and firmly tighten using hand strength only (fig 35).

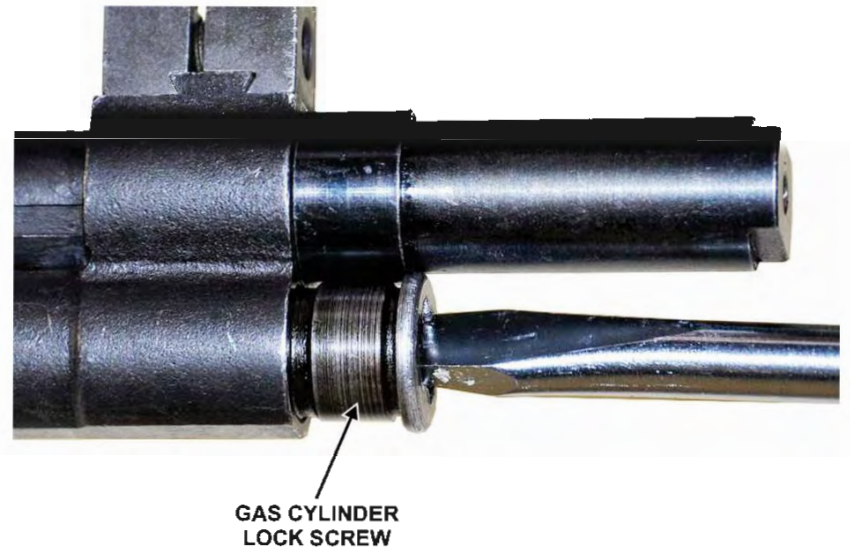

Figure 35. Gas cylinder lock screw installation

- 6) To replace the bolt, hold the rifle upright and guide the rear lug of the bolt into its groove on the left side of the receiver (fig 36).

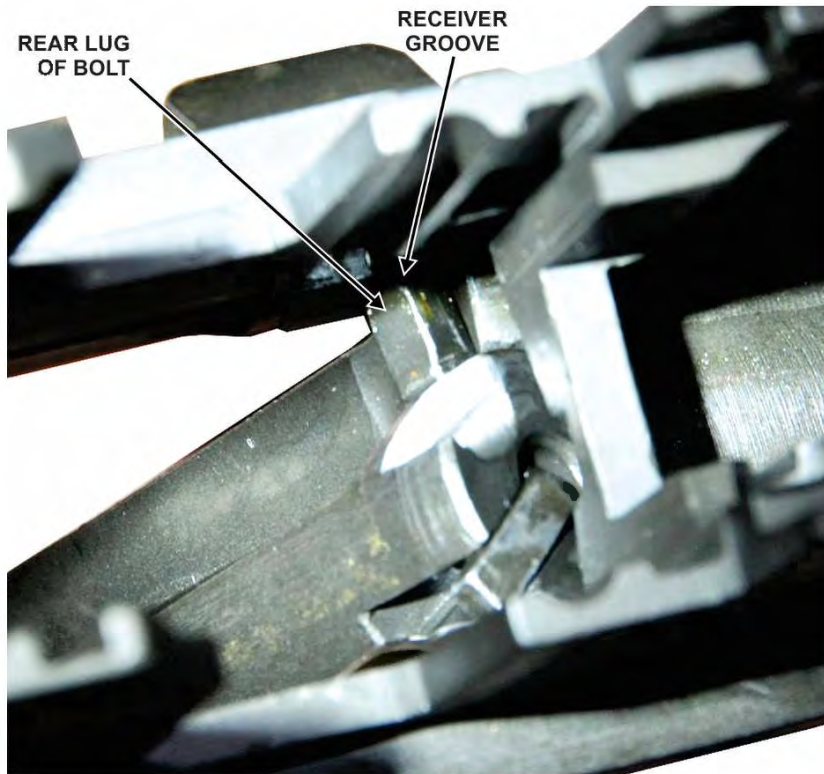

Figure 36. Rear lug in groove on receiver

- 7) Rotate the bolt so that the tang of the firing pin clears the notch in the bridge of the receiver (fig 37). Align the right locking lug on its bearing surface and slide the bolt to the rear.

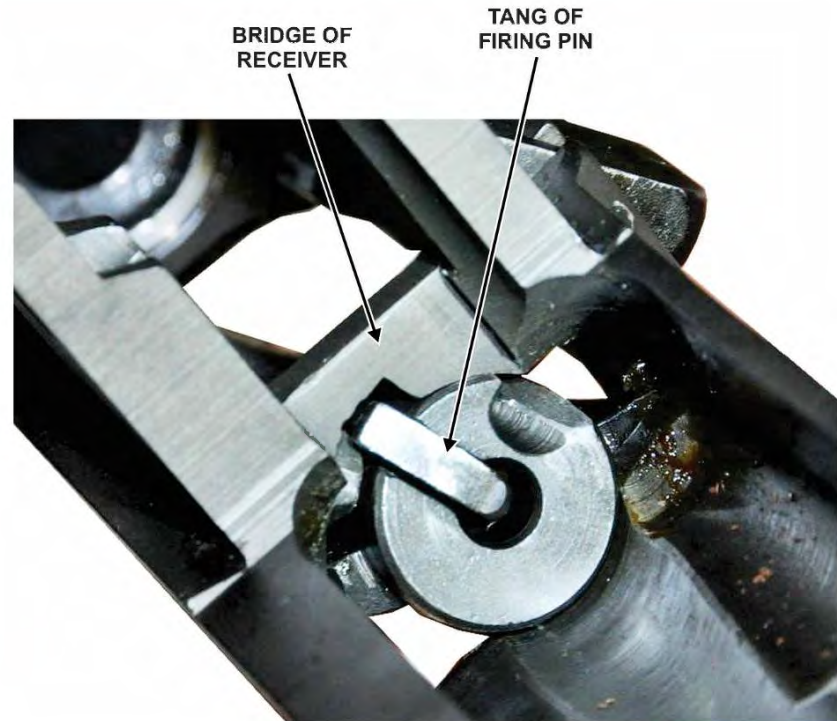

Figure 37. Tang clearing notch in bridge of receiver

Note: Figures 36 and 37 show the rifle inverted. It is not necessary to invert the rifle but the figures are provided to aid in the bolt insertion.

- 8) To replace the operating rod, place the piston end into the gas cylinder while weapon is inverted (fig 38).
- 9) Rotate the weapon upright and align the operating rod so that the recess in the hump fits over the operating lug of the bolt (figs 39 and 40). Move the operating rod fully rearward and then forward until the bolt is closed.

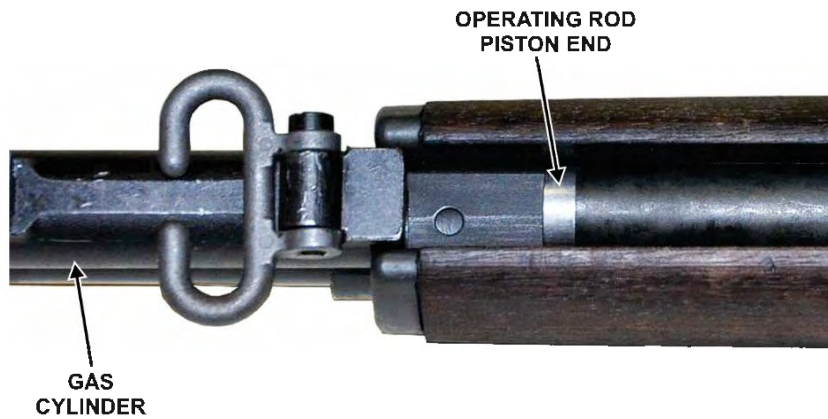

Figure 38. Operating rod piston end insertion

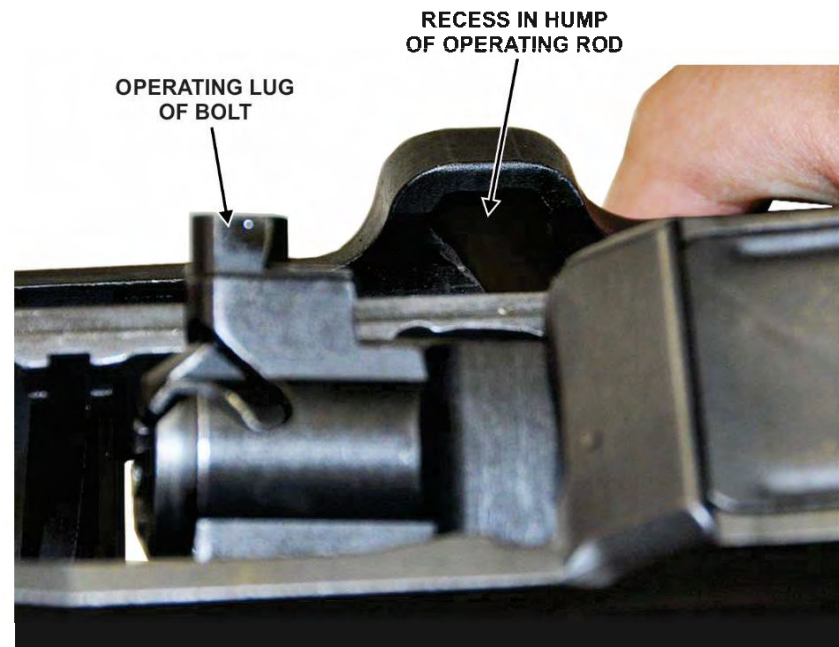

Figure 39. Recess in the hump and operating lug of bolt

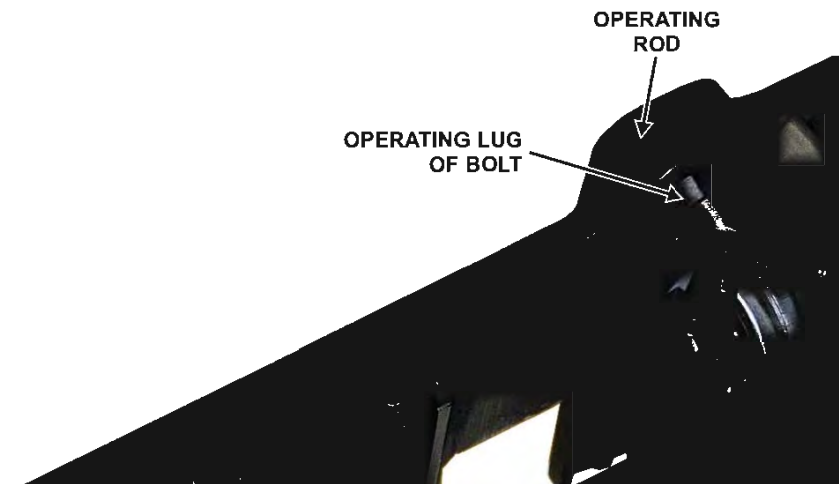

Figure 40. Operating rod replaced

- 10) Invert weapon and replace the follower assembly so that its guide ribs fit into their corresponding grooves on the receiver. Make sure that the slide of the follower is down and that the square hole is to the rear (fig 41). The slide will rest against the bolt.

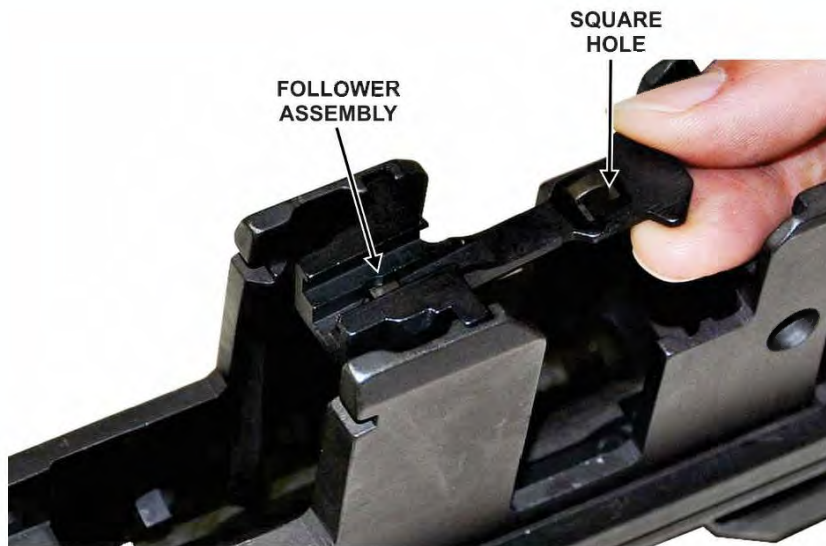

Figure 41. Follower assembly insertion

- 11) Place the bullet guide so that its shoulders fit into their corresponding notches in the receiver and the bullet guide hole is aligned with the holes in the receiver (fig 42).

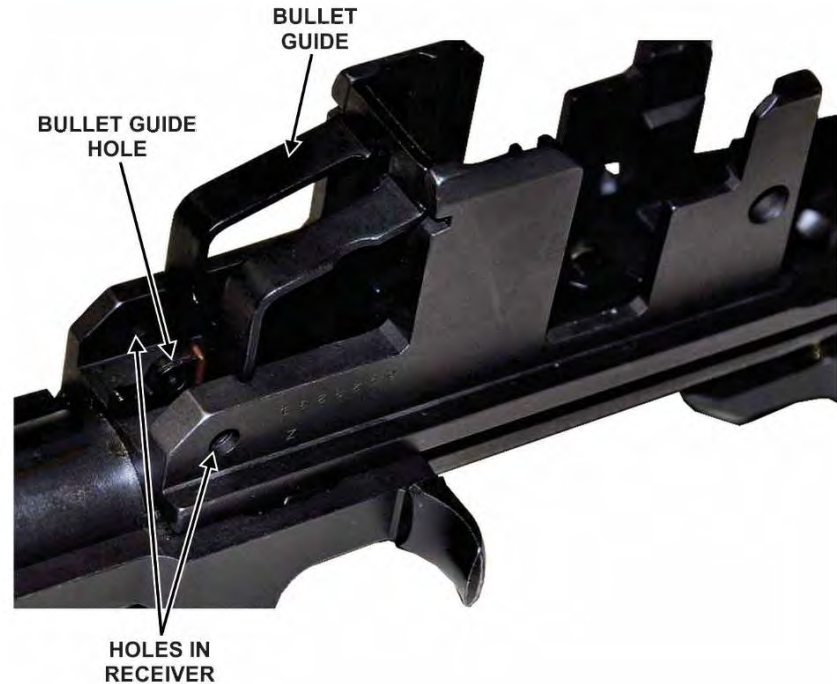

Figure 42. Bullet guide insertion

- 12) Slightly lift up the lower part of the bullet guide. Insert the rear arm of the operating rod catch through the clearance cut in the side of the bullet guide (fig 43). Make sure that the rear arm is placed underneath the front lug of the clip latch which projects into the receiver (figs 44 and 45). Lower the bullet guide into place.



Figure 43. Rear arm of operating rod catch

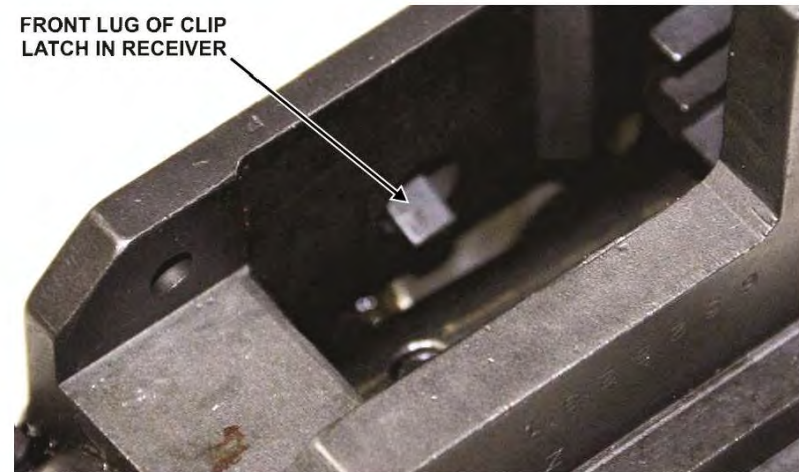

Figure 44. Lug in receiver

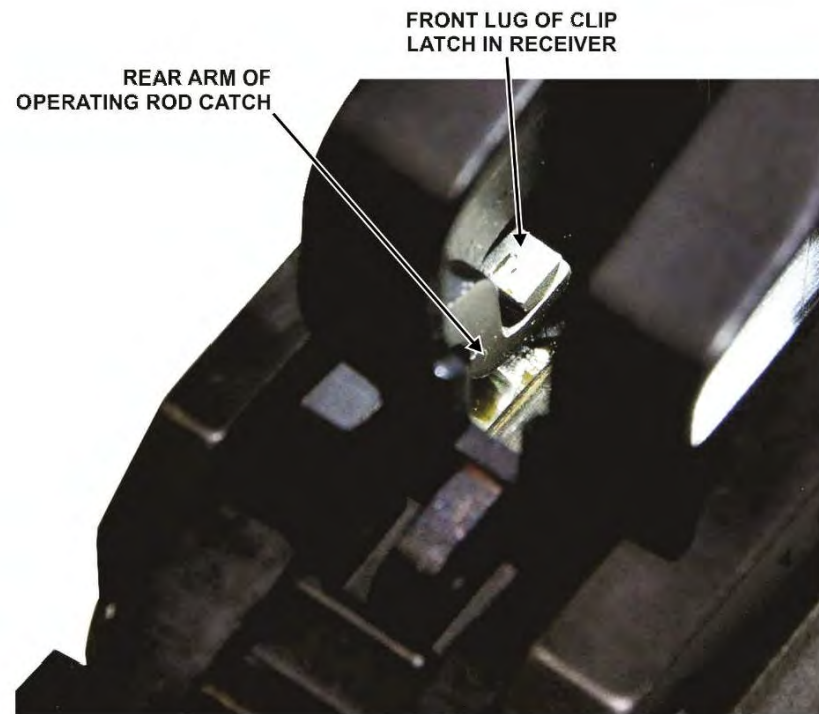

Figure 45. Rear arm of operating rod catch underneath lug of clip latch

- 13) Test for correct assembly by pressing down on the front arms of the operating rod catch assembly (fig 46). It should move and you should be able to feel the tension of the clip latch spring.

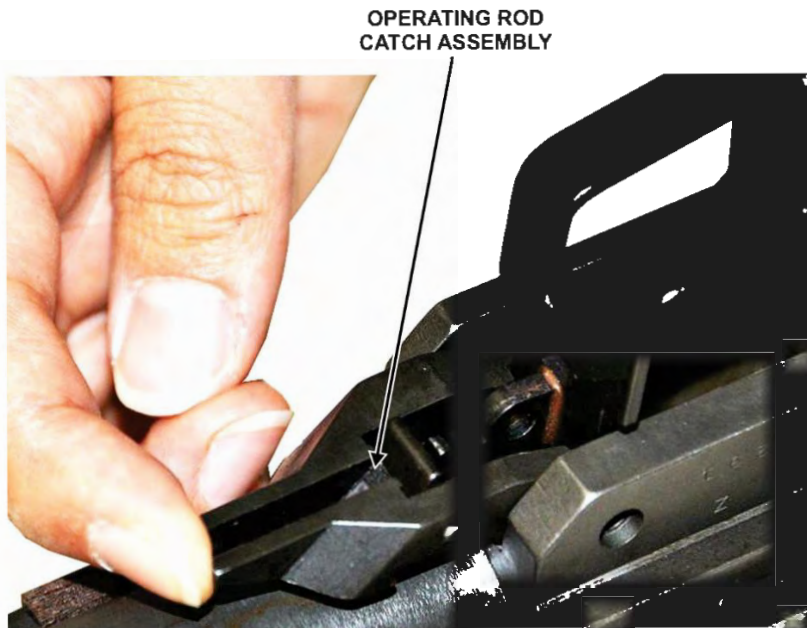

Figure 46. Testing operating rod catch assembly

- 14) Lift the follower assembly and install the follower arm by passing its rear studs through the bullet guide and inserting them into the guide grooves on the follower assembly (fig 47).
- 15) Align the holes in the operating rod catch assembly, follower arm, and bullet guide with those in the receiver and push the follower arm pin through from the operating rod side (figs 48 and 49).



Figure 47. Installing follower arm



Figure 48. Follower arm engaged

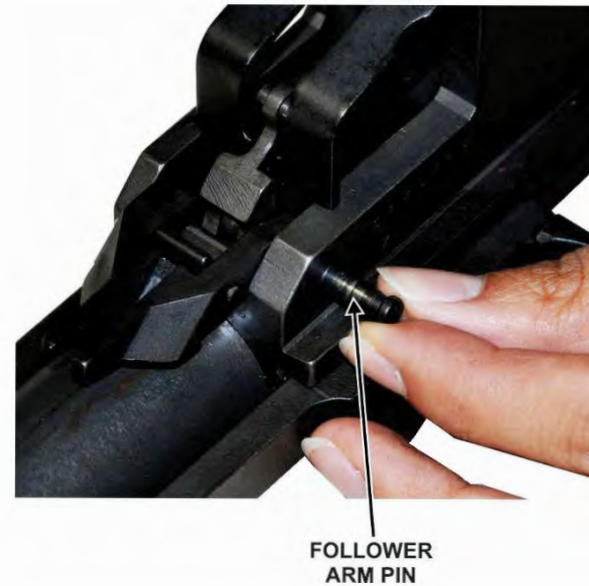

Figure 49. Insertion of follower arm pin

- 16) Insert the loose end of the operating rod spring into the operating rod (fig 50).
- 17) Grasp the follower rod, making sure that its hump is down toward the barrel (fig 51). Compress the operating rod spring and engage the forks of the follower rod with the front studs of the follower arm (fig 52). You may have to raise the follower assembly to do this.

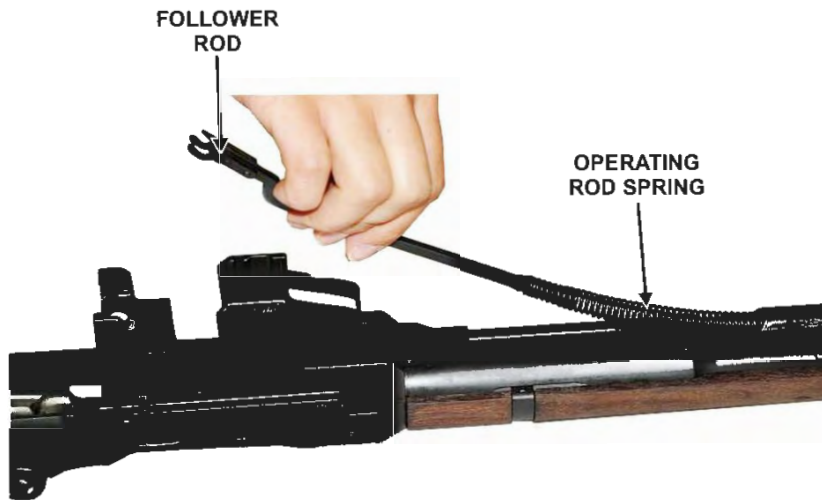

Figure 50. Orientation of follower rod

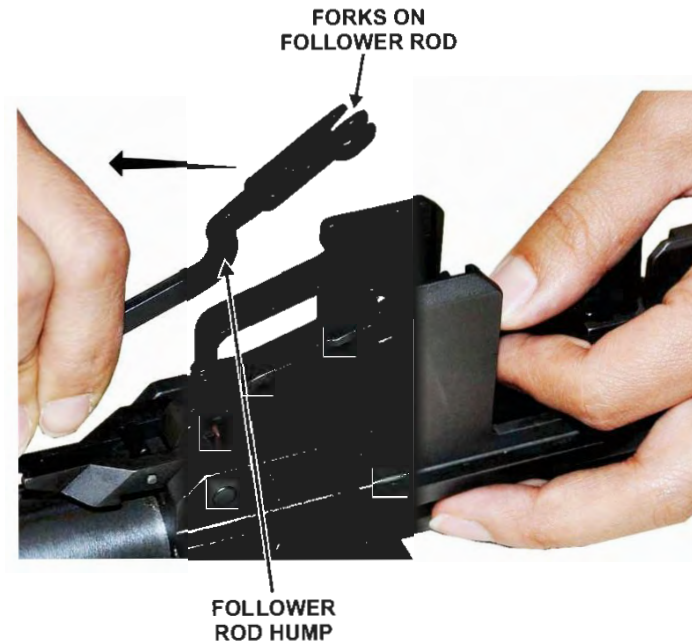

Figure 51. Orientation of follower rod

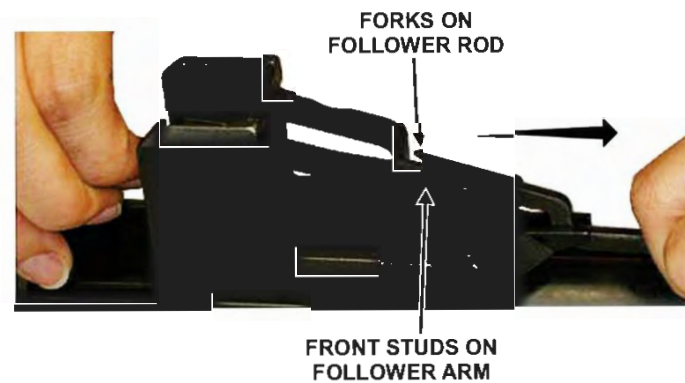

Figure 52. Insertion of operating rod spring

2.7 Assembly of the Three Main Groups

- 1) Pick up the stock group and engage the U-shaped flange on the front of the stock into the lower band of the barrel and receiver group, then lower the stock group onto the barrel and receiver group (fig 53).

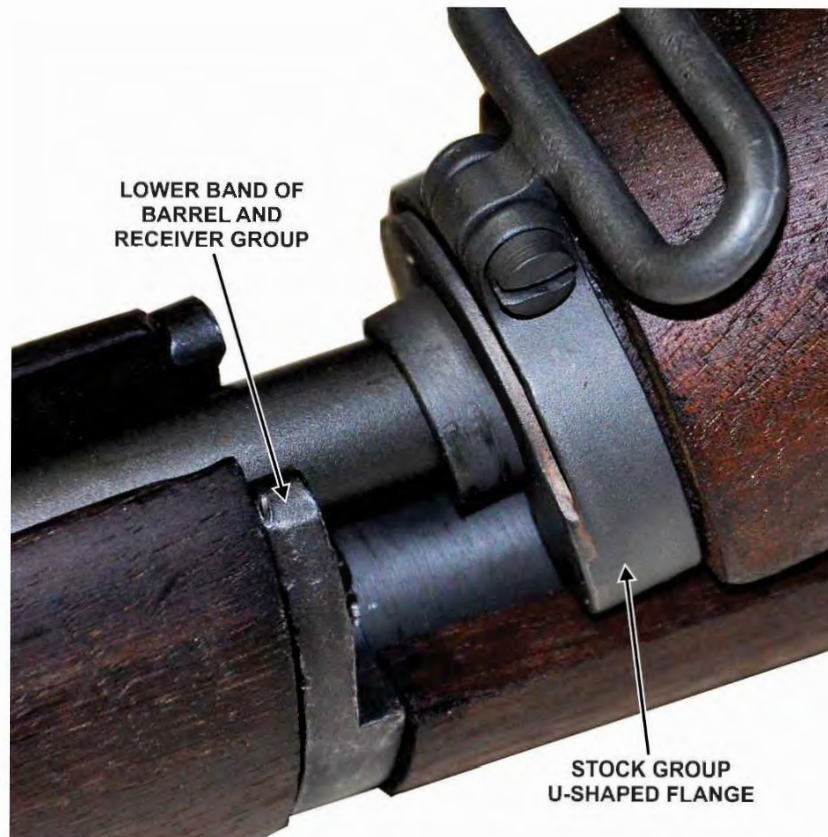

Figure 53. Assembly of stock group

- 2) Unlatch and open the trigger guard. Keeping the trigger group level, insert it straight down into the receiver, making sure that the locking lugs on the trigger guard enter their recesses in the receiver (fig 54).
- 3) Close the trigger guard and latch it by pressing firmly down until it locks. You may need to strike it with the heel of your hand to lock it. The rifle is now fully assembled.

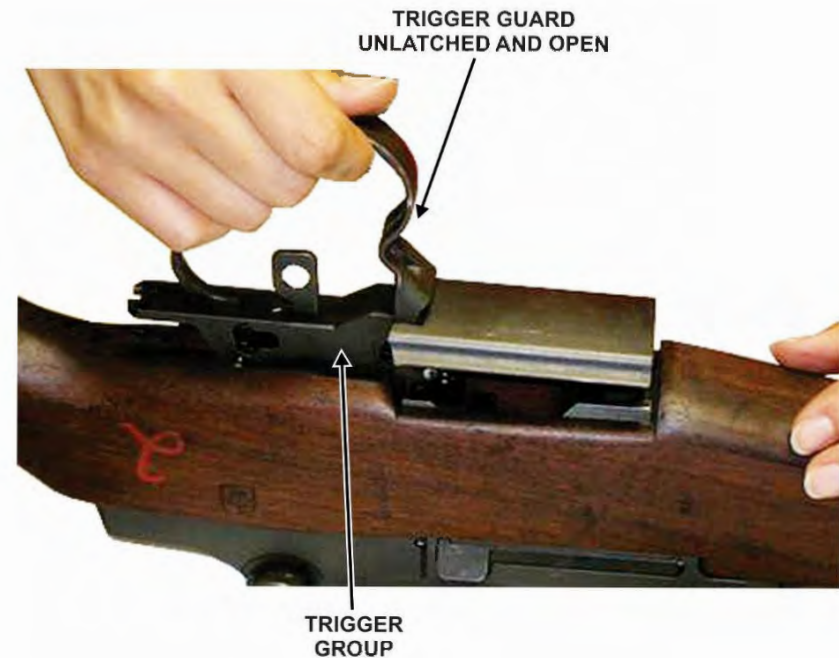

Figure 54. Insertion of trigger group

2.8 Blank Firing Adapter (BFA)

The threads on the BFA and where it screws into the barrel should be examined. For lock screw assembly/tightening procedure, see section 2.6.

2.9 Test for Correct Assembly

Each time the rifle is disassembled and assembled it should be tested to make sure that it is put together properly. To do this, pull the operating rod to its rearmost position. The bolt should stay open. Close the bolt and snap the safety to its locked position. Squeeze the trigger. The hammer should not fall. Push the safety to its unlocked position and squeeze the trigger. The hammer should fall. This test checks the operation of the safety.

3.0 Operation and Functioning

3.1 Loading Rounds into a Clip

- 1) Start placing rounds in the lower left of the clip and make sure that each round is against the rear wall so that the inner rib of the clip engages the extracting groove of each round (fig 55).
- 2) *Each time rounds are loaded into a clip, the clip should be checked for long rounds.* If one round extends beyond the others, it is possible that a live round has been mixed in with blanks.

WARNING: Make sure you NEVER fire any ammunition other than the supplied blanks in your rifle. Firing unauthorized ammunition may result in severe injury to yourself and others nearby, or damage to the weapon.



Figure 55. Loading rounds into clip

3.2 Loading the Rifle

To load a single round, pull the operating rod all the way to the rear. While holding the muzzle below the horizontal, place a round in the chamber and seat it with your thumb. With the knife edge of the right hand against the operating rod handle, force the operating rod slightly to the rear. Push down on the follower assembly with the right thumb and allow the bolt to ride forward. Remove the thumb from the follower assembly and release the operating rod handle, allowing the operating rod to go all the way forward.

To load a clip, hold the rifle and pull the operating rod handle all the way to the rear. Place the clip on top of the follower assembly. Place your thumb on the center of the top round in the clip (fig 56) and press the clip straight down into the receiver until it latches. Remove your hand and allow the bolt to travel forward freely. Note that the operating rod is not held to the rear after fully inserting a loaded clip. In order to chamber the first round, it may be necessary to strike the back of the operating rod handle with the heel of the right hand to fully close and lock the bolt.



Figure 56. Loading of clip into rifle

3.3 Unloading the Rifle (not due to a misfire)

To unload a round from the chamber, support the rifle, and with the right hand, grasp the operating rod handle and pull the operating rod slowly to the rear. At the same time, place the left hand, palm down, over the receiver to catch the round as it is ejected.

To unload a clip, unload the round that is in the chamber as described above. When the operating rod reaches its rearmost position, hold it there. Place the palm of the left hand over the receiver and depress the clip latch (fig 57) with the left thumb, allowing the clip to be ejected up into the hand. Do not relax the rearward pressure on the operating rod handle until after the clip has been removed.

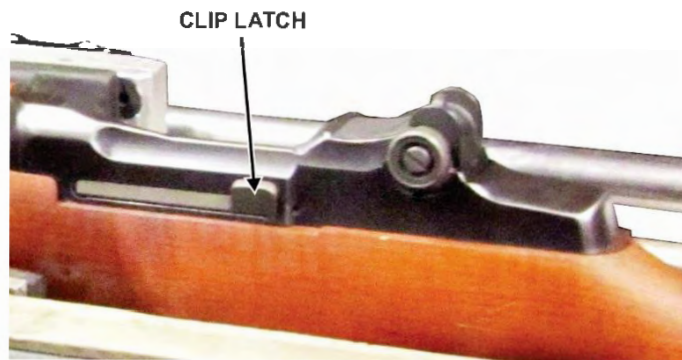

Figure 57. Clip latch

3.4 Functioning of the Rifle

- 1) **Feeding.** Feeding takes place when a round is moved into the path of the bolt. This is done through the follower assembly exerting upward force on the remaining rounds within the clip. The follower assembly exerts continuous upward force on the remaining rounds through compression of the operating

rod spring through its connection to the follower rod and follower arm (fig 58).

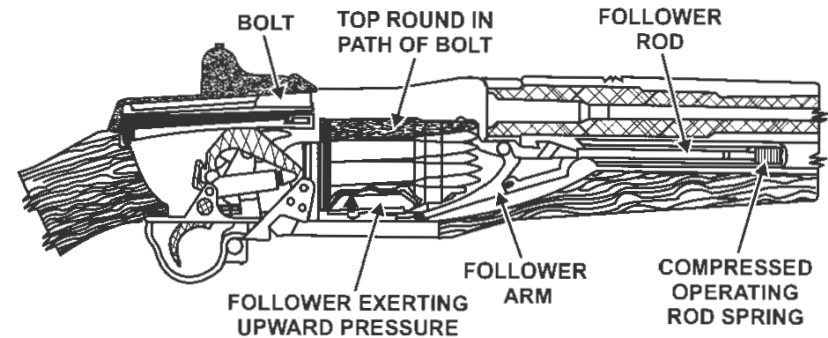

Figure 58. Position of parts when the bolt is in the rearmost position

- 2) **Chambering.** Chambering occurs when a round is moved into the chamber. This takes place as the bolt goes forward under force from the operating rod spring, picking up the top round in the clip and driving it forward into the chamber. Chambering is complete when the extractor snaps into the extracting groove on the cartridge case and the ejector is forced into the face of the bolt (fig 59).

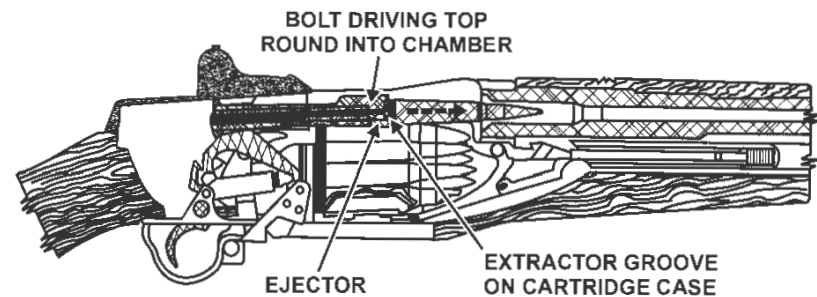

Figure 59. Chambering

- 3) **Locking.** Locking is complete when the bolt is fully closed. The bolt is moved into its fully locked position through the camming action of the operating rod which forces the operating lug of the bolt down. This engages the locking lugs on the bolt with their recess in the receiver (fig 60).

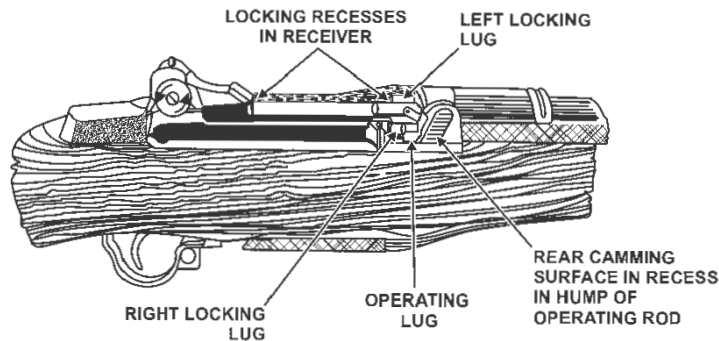

Figure 60. Locking

- 4) **Firing.** Firing occurs when the firing pin strikes the primer. As the trigger is pulled the trigger lugs are disengaged from the hammer hooks and the hammer is released. The hammer moves forward under the force of the hammer spring and strikes the tang of the firing pin, driving the firing pin against the primer and firing the round (fig 61).

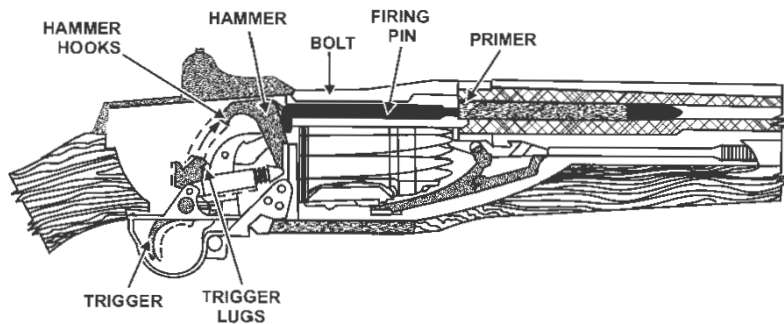

Figure 61. Firing

- 5) **Unlocking.** Unlocking occurs after the round is fired. Once the round is initiated, a small portion of the gas expands through the gas port into the gas cylinder, forcing the operating rod to the rear (fig 62). The camming surface inside the recess in the hump of the operating rod, in combination with the guideway in the side of the receiver, forces the operating lug of the bolt upward, disengaging the locking lugs from their recesses in the receiver. The bolt is thus unlocked and ready to be moved to the rear.

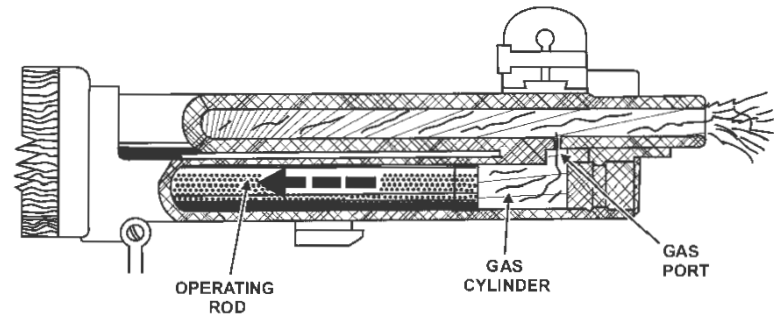

Figure 62. Action of gas moving operating rod

- 6) **Extracting.** Extracting is the pulling of the empty cartridge case from the chamber. The extractor, which is engaged with the extracting groove on the cartridge case, withdraws the empty case as the bolt moves to the rear (fig 63).

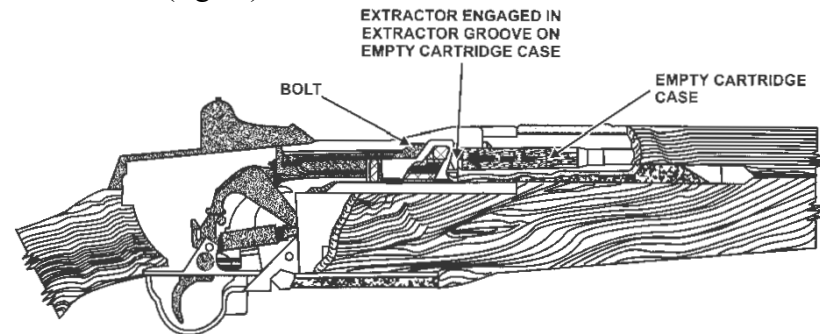

Figure 63. Extracting an empty cartridge case

- 7) **Ejecting.** Ejecting is throwing the empty case from the rifle. As the bolt moves to the rear, withdrawing the case from the chamber, the round is held in place by the chamber walls. When the mouth of the empty case clears the chamber, it is ejected up and to the right due to the force exerted by the ejector (fig 64).

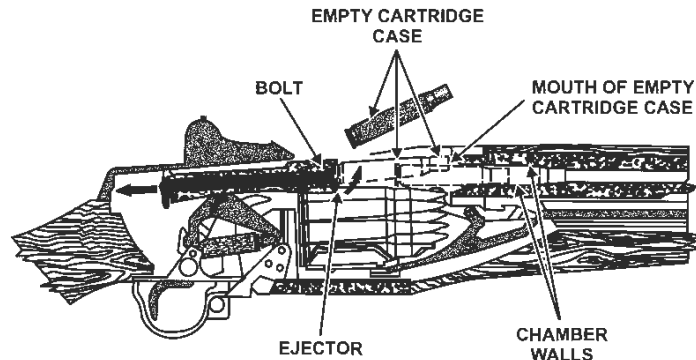

Figure 64. Ejecting an empty cartridge case

- 8) **Cocking.** Cocking occurs when the hammer is forced into the proper position for firing the next round. This happens as the bolt moves to the rear. The rear end of the bolt forces the hammer back and rides over it. The hammer is caught by the sear if the trigger is still held to the rear, and is caught by the trigger lugs if trigger pressure has been released (fig 65).

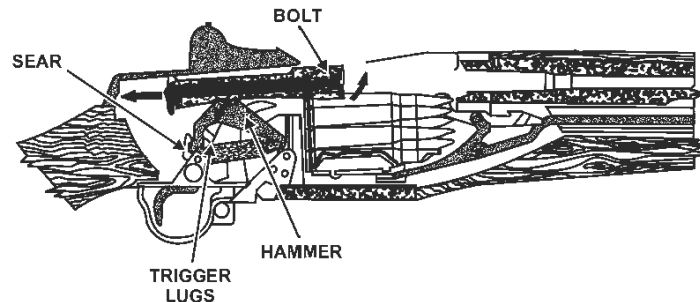

Figure 65. Ejecting an empty cartridge case

4.0 Stoppage, Immediate Action, Malfunctions, and Ammunition Malfunction Reporting

A stoppage is any unintentional interruption in the cycle of operation. Most stoppages occur because of dirty, worn, or broken parts, and/or lack of lubrication. The user should watch for these defects and take corrective action to eliminate them before they cause a stoppage. Some of the more common stoppages, with their usual causes and remedies, are shown in Table 1.

4.1 Immediate Action

Immediate action is the prompt action taken by the user to overcome a stoppage. To perform immediate action, pull the operating rod handle all the way to the rear with the right hand, palm up then release it. Next, aim the rifle and try to fire it.

4.2 Malfunctions

A malfunction is a failure of either the weapon or ammunition to function as intended.

Normally, the user will instinctively apply immediate action which in most instances will overcome or correct the stoppage even when caused by a hangfire or misfire. Misfires are caused by one of three factors: the user, the weapon (due to excessive dirt, residue, etc.), or faulty ammunition. When misfires are caused by faulty ammunition, the lot number should be reported to JMC. The alpha-numeric lot numbers are printed on the ammunition can.

Table 1. Malfunctions, Probable Causes and Actions/Remedies

<u>Stoppage/Malfunction</u>	<u>Probable Cause</u>	<u>Action/Remedy</u>
Failure to load	• Damaged clip	• Replace clip.
	• Improperly assembled receiver components	• Disassemble and reassemble. (Section 2.4-2.7)
Failure to feed ammunition	• Lack of lubrication of operating parts	• Clean and lubricate parts. (Section 5.1-5.2)
	• Defective or worn follower rod/operating rod spring	• Replace follower rod/operating rod spring. (Section 2.4-2.7)
	• Short recoil	• See “Short recoil” stoppage/malfunction in this table.
Failure to chamber ammunition	• Lack of lubrication of operating parts	• Clean and lubricate parts. (Section 5.1-5.2)
	• Dirty chamber	• Clean chamber. (Section 5.2)
	• Defective ammunition	• Replace ammunition.
Failure to lock bolt	• Lack of lubrication of operating parts	• Clean and lubricate parts. (Section 5.1-5.2)
	• Dirty chamber	• Clean chamber. (Section 5.2)
	• Dirty locking recesses	• Clean recesses. (Section 5.2)
	• Weak operating rod spring	• Replace follower rod/operating rod spring. (Section 2.4-2.7)
Failure to fire ammunition	• Bolt not in battery	• See “Bolt fails to close tightly” stoppage/malfunction in this table.
	• Defective ammunition	• Replace ammunition.
	• Defective firing pin	• Replace firing pin - contact CMP.
	• Defective trigger housing group	• Replace trigger housing group. (Section 2.4 and 2.7)
	• Weak or broken hammer spring	• Replace trigger housing group. (Section 2.4 and 2.7)
Failure to unlock bolt	• Dirty chamber	• Clean chamber. (Section 5.2)
	• Lack of lubrication of operating parts	• Clean and lubricate parts. (Section 5.1-5.2)
	• Insufficient gas	• Tighten and/or clean gas cylinder lock screw, and/or adjust or replace gas cylinder. (Section 5.1-5.2 or 2.4-2.7)
	• Follower arm pin worn	• Replace follower arm. (Section 2.4-2.7)
	• Follower arm bent or out of tolerance	• Replace follower arm. (Section 2.4-2.7)
Failure to extract spent cartridge case	• Dirty chamber	• Clean chamber. (Section 5.2)
	• Defective ammunition	• Replace ammunition.
	• Broken extractor	• Replace extractor - contact CMP.
Failure to eject cartridge case	• Broken ejector or spring	• Replace ejector or spring - contact CMP.
	• Short recoil	• See “Short recoil” stoppage/malfunction in this table.

Table 1. Malfunctions, Probable Causes and Actions/Remedies (continued)

<u>Stoppage/Malfunction</u>	<u>Probable Cause</u>	<u>Action/Remedy</u>
Failure to cock hammer	• Defective trigger housing group	• Replace trigger housing group. (Section 2.4 and 2.7)
	• Short recoil	• See “Short recoil” stoppage/malfunction in this table.
Cartridge clip inserts with difficulty	• Deformed cartridge clip	• Replace cartridge clip.
	• Broken clip ejector	• Replace clip ejector - contact CMP.
	• Interference between bullet guide and follower arm	• Replace bullet guide or follower arm. (Section 2.4-2.7)
	• Bad follower assembly	• Replace follower assembly. (Section 2.4-2.7)
Short recoil (operating rod does not fully cycle)	• Gas cylinder lock screw loose	• Tighten lock screw. (Section 2.6)
	• Undersized or out of round operating rod piston	• Replace operating rod. (Section 2.4-2.7)
	• Improperly installed or oversized gas cylinder	• Adjust gas cylinder (Section 2.6) or replace gas cylinder. (Section 2.4-2.7)
	• Carbon in gas cylinder or barrel port	• Clean gas cylinder or barrel port. (Section 2.4-2.7 and 5.2)
	• Operating rod assembly binding	• Replace operating rod assembly if damaged, or relieve wood from gun stock assembly, where operating rod binds on wood. (Section 2.4-2.7)
	• Leak in gas cylinder lock screw with valve	• Replace gas cylinder lock screw with valve. (Section 2.4-2.7)
	• Defective operating rod spring.	• Replace operating rod spring. (Section 2.4-2.7)
	• Bolt binding	• Remove burs from bolt - contact CMP.
Bolt fails to close tightly	• Distorted or damaged receiver	• Replace receiver - contact CMP.
	• Extractor does not snap over rim of cartridge	• Clean bolt assembly and extractor recess. (Section 5.2)
	• Operating rod assembly binding	• Replace operating rod assembly if damaged, or relieve wood from gun stock assembly, where operating rod binds on wood. (Section 2.4-2.7)
	• Weak or broken operating rod spring	• Replace follower rod/operating rod spring. (Section 2.4-2.7)
	• Dirty chamber	• Clean chamber. (Section 5.2)
	• Frozen ejector spring and plunger	• Replace ejector spring and plunger - contact CMP.
	• Damaged bolt and/or receiver	• Replace bolt or receiver - contact CMP.
• Insufficient headspace	• Replace bolt assembly by selective fit or headspace - contact CMP.	

4.3 Ammunition Malfunction Reporting

In the event of an ammunition malfunction contact the U.S. Army Joint Munitions Command (JMC):

Ammunition Surveillance Division (AMSJM-QAS)

2695 Rodman Ave

Rock Island, Illinois 61299-6000

DSN 793-7295

COMM 309-782-7295

FAX 309-782-7136

usarmy.ria.jmc.mbx.amsjm-qas@mail.mil

Mailing address:

U.S. Army Joint Munitions Command, AMSJM-QAS

2695 Rodman Ave, Rock Island, IL 61299-6000

5.0 Maintenance

5.1 Cleaning Materials, Lubricants, Equipment, and Parts

See CMP's website or contact CMP (see section 1.1 of this guide for contact information) for current information on how and where to obtain cleaning materials, lubricants, equipment, and parts.

5.1.1 Cleaning Solutions

- 1) Bore cleaner should be used as the primary cleaning solvent for cleaning the bore.
- 2) Hot, soapy water or boiling water is no substitute for bore cleaner and should not be used.
- 3) Commercially available linseed oil

WARNING: Personnel must take protective measures when using cleaning solutions.

5.1.2 Lubricants

- 1) Lubricating gun oil or grease is used for lubricating the rifle at normal temperatures. It should be applied to the areas shown in Figures 66 through 68. Apply lube sparingly to key points.

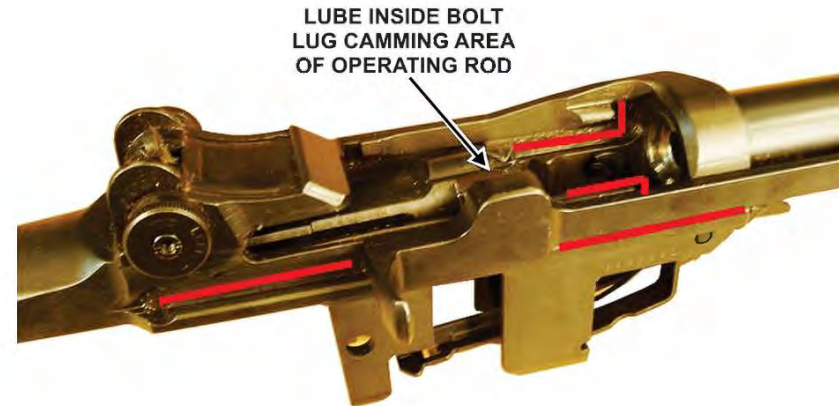

Figure 66. Lubrication

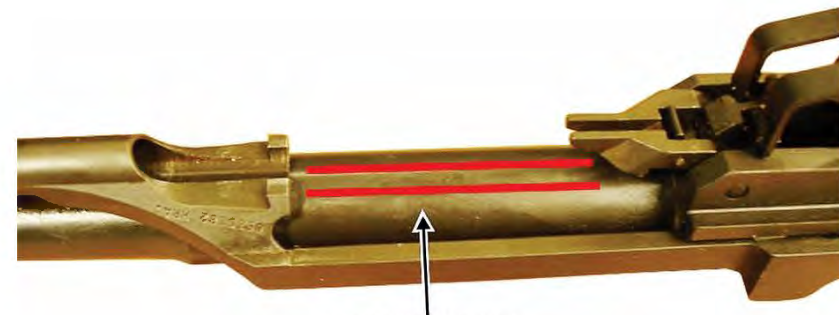

Figure 67. Lubrication

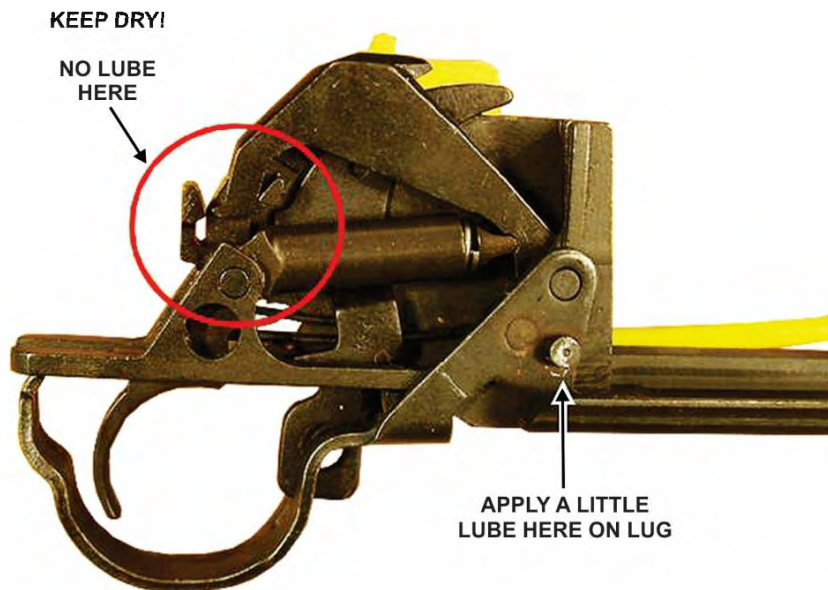

Figure 68. Lubrication

5.1.3 Equipment

5.1.3.1 Cleaning Equipment

- Small arms .30 cal bore cleaning brush
- Lubricant
- Chamber cleaning brush
- Cleaning rod (commercially available)
- Shop rags or lint-free towels

5.1.3.2 Blank Firing Adapter

The optimal vent hole size for a BFA is **0.172** inches. Blank firing adapters can be purchased pre-drilled to this size from commercial retailers. This BFA will typically result in the best performance of a M1 Rifle in good operating condition. The BFA should be cleaned along with the rest of the weapon. Use

a .22 caliber brush or similar device to clean the hole and a rag or brush to clean all available surfaces.

5.2 Cleaning the Rifle

The rifle should be thoroughly cleaned no later than the evening of the day it is fired, particularly if the weapon is not expected to be used within the next few days.

5.2.1 Chamber

Remove the patch holder from the cleaning rod and insert two patches about halfway through the slot. Dip the patches in bore cleaner, then wring or squeeze the excess fluid from the patches. Screw the cleaning rod together (without the patch holder) and insert it all the way into the bore. Flare the patches out, then insert the patch holder with the wet patches into the chamber. Push the threaded end into the chamber until it touches the cleaning rod. Hold it there with one hand and screw the cleaning rod and the patch holder together. Pull the patches to the chamber, at the same time turning the rod clockwise. Turn the rod several times, wiping the chamber thoroughly. After the chamber has been thoroughly cleaned, use the chamber brush in the following manner:

- 1) Screw a section of the cleaning rod into a threaded hole of the driver ratchet.
- 2) Place the brush into chamber of the barrel.
- 3) Allow the rifle bolt to slowly close against the end of the driver ratchet.
- 4) Using the rod section as a handle, rotate the driver both clockwise and counterclockwise to loosen and clean residue from the chamber.
- 5) Insert a dry patch in the patch holder and insert into the chamber to remove any excess bore cleaner.

5.2.2 Bore

To clean the bore, saturate the bore brush with cleaning compound solvent (rifle bore cleaner) and:

- 1) Insert the bore brush into the chamber. Insert the cleaning rod into the bore and screw the brush onto the rod.
- 2) Pull the brush through the bore. Remove the brush and repeat the procedure as often as required to clean the bore.
- 3) Use one cleaning patch dampened with bore cleaner in the following manner:
 - a) Place the patch in the patch holder and insert it into the chamber.
 - b) Insert the cleaning rod (without the patch holder) into the bore and screw it onto the patch holder.
 - c) Pull the cleaning rod through the bore. Repeat this procedure using as many patches as required until the patches come through the bore clean.
- 4) Remove the excess bore cleaner in the following manner:
 - a) Place a dry patch in the patch holder and insert it into the chamber.
 - b) Insert the cleaning rod (without the patch holder) into the bore and screw it onto the patch holder.
 - c) Pull the cleaning rod through the bore. Repeat this procedure using as many patches as required until the patches come through the bore clean.

5.2.3 Gas Cylinder Lock Screw Assembly

Remove carbon deposits by using bore cleaner, and then wipe the part and oil it lightly (do not use abrasives). Check the valve to make sure it is not held open by particles of dirt or sand.

5.2.4 Piston Operating Rod

Remove carbon from the piston with bore cleaner. Take care not to damage the piston. Oil it lightly after cleaning (do not use abrasives).

5.2.5 Gas Cylinder

Clean the gas cylinder with bore cleaner and patches. Once complete, the bore cleaner must be removed with dry, clean patches or a clean cloth.

5.2.6 Face of the Bolt

Clean the face of the bolt with a patch and bore cleaner, paying particular attention to its inside edges. Remove the bore cleaner with dry patches and oil the part lightly.

5.2.7 Rifle Stock

Use a dry, lint free towel to remove all dirt, sand, or foreign material from the surface of the stock. Apply a commercially available linseed oil to the surface of the stock (wood only) and allow to stand for two hours to be absorbed. After two hours, wipe off any excess oil and polish with a clean dry cloth. Be careful not to allow linseed oil to get into crevices of mechanism as it will form a residue as it dries.

NOTE: If there is a question concerning the serviceability of an M1 Garand stock, CMP should be contacted for disposition recommendations. They can be contacted at: Civilian

Marksmanship Program, 1401 Commerce Blvd., Anniston, AL 36207 Tel. 256-835-8455/Fax. 256-835-3527, www.thecmp.org.

5.2.8 All Other Parts

Use a dry cloth to remove all dirt or sand from other parts and exterior surfaces. Apply a light coat of oil to the metal parts.

5.3 Routine Maintenance

5.3.1 Daily Inspection

When in use, the rifle should be inspected daily for evidence of burred, worn, or cracked parts, rust and general appearance. A light coat of oil (any protective lubricant) should be maintained on all metal parts.

5.4 Blank Firing Adapter/Barrel Inspection Criteria

5.4.1 BFA Inspection

Disassembly

1. While holding the M1 Garand Rifle, use a flat tip screw driver to unscrew and remove the **Gas Cylinder Lock Screw** from the **Gas Cylinder** (Figure 69).
2. Then unscrew and remove the **Blank Firing Adapter** from the **M1 Garand Barrel**. Please note, if the **BFA** cannot be removed by hand, use a 7/16-inch wrench and apply light pressure to remove the **BFA**.

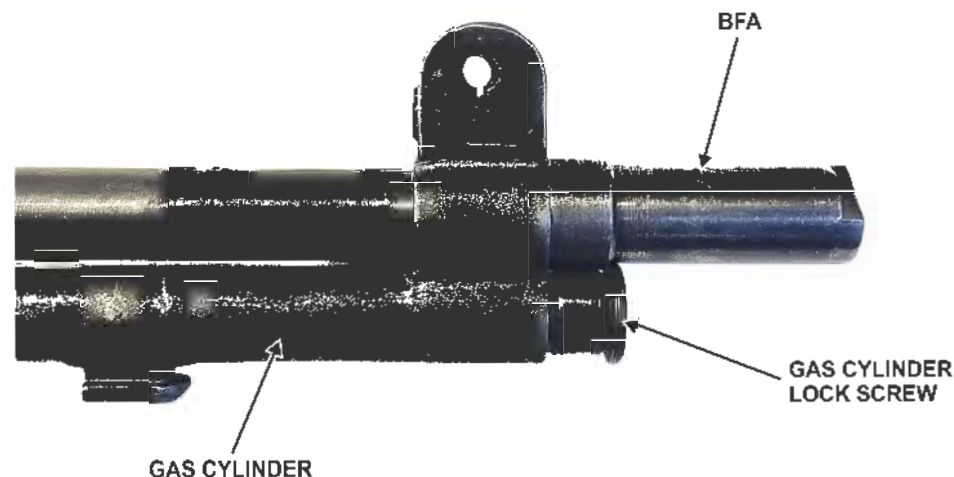

Figure 69: M1 Garand Rifle

BFA Inspection

NOTE

The BFA should be cleaned properly prior to conducting inspection.

3. Once removed, check the **BFA** for any signs of structural damage, which include but are not limited to the following:
 - a. Any cracks along the orifice, base, or surface of the BFA
 - b. Any dents or bends on the BFA
 - c. Any deep scratches on the BFA
 - d. Any punctures on the BFA
 - e. Thread wear
 - f. Corrosion on the threads

If any of the damage listed above in a. – f. or any damage that is observed but not listed is found, the BFA should not be used and should be replaced with a serviceable BFA.

If corrosion is found on the threads, the threads should be cleaned with a 9/16" steel bristle tube brush, a clean rag and penetrating oil. Once the corrosion is removed from the threads, the threads should be inspected again for signs of damage from the corrosion, which include thread wear and pitting. If any damage is found, the BFA should not be used and should be replaced with a serviceable BFA.

4. If the BFA does not show any signs of structural damage, the orifice in the BFA should be inspected. The orifice of the BFA should be 0.172 -0.002/+0.005 inches in diameter. An orifice of 0.172" is the optimal diameter for firing the M1909 blank cartridge in the M1 Garand for ceremonial purposes.
 - a. To complete this inspection, the following pin gauges will be needed:

Pin A: Class Z 0.177 plus pin (0.177" - 0.0000"/+0.0001")

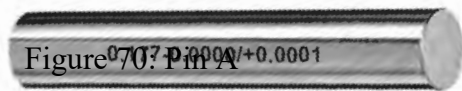

Pin B: Class Z 0.177 minus pin (0.177" - 0.0001"/+0.0000")

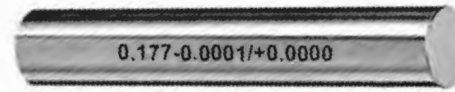

Figure 71: Pin B

Pin C: Class Z 0.170 plus pin (0.170" - 0.0000"/+0.0001")

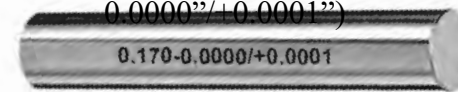

Figure 72: Pin C

CAUTION

When conducting an inspection with a pin gauge, the inspection should be conducted at surface level over a clean flat soft surface (such as a table covered with a rubber mat) so that if the gauge is dropped, it is dropped from a minimal height and that it lands on a surface that will prevent damage to the gauge.

NOTE

Pin Gauges should be stored in a clean dry place to prevent corrosion. If the gauge shows signs of corrosion or damage, the gauge should not be used for the inspection and should be replaced.

- b. When conducting a pin gauge inspection, the pin should be held along its side with minimal pressure between the thumb and index finger (Figure 73). The gauge should never be held in a manner that puts pressure on the end of the pin (Figure 74).



Figure 73: Proper Hold



Figure 74: Improper Hold

- c. When conducting the inspection, the pin should fit in the hole by “falling” into the hole without

any resistance and without exerting pressure on the pin. Never use pressure to “force” the pin into the hole.

- d. The hole should be inspected with pins A-C in order and whether the pin could be inserted into the hole should be recorded. The results from the inspection should be compared with the following chart to determine if the orifice is serviceable.

	Pin A	Pin B	Pin C	Orifice Results
Inserted		—	—	
Cannot Be Inserted		Inserted		
Cannot Be Inserted	Inserted			

- e. If the BFA orifice is determined to be not serviceable, the BFA should not be used and should be replaced with a serviceable BFA.

5. If the BFA orifice is serviceable, the thread diameter of the BFA should be inspected. The thread diameter of the BFA should be $0.5287 -0.0000/+0.0046$ inches.

- a. For this inspection a standard dial caliper (Figure 75) or electronic caliper (Figure 76) with an accuracy of ± 0.001 " will be needed.



Figure 75: Dial Caliper

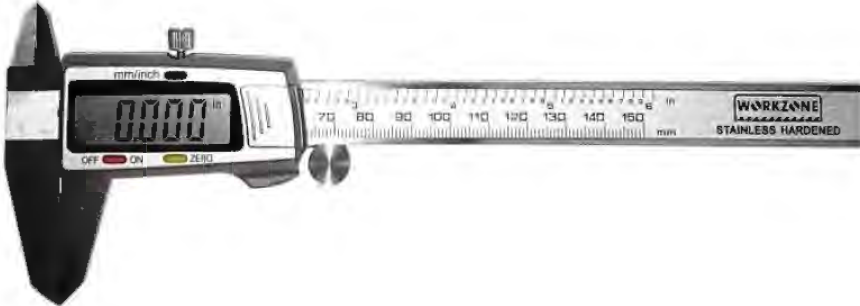

Figure 76: Electronic Caliper

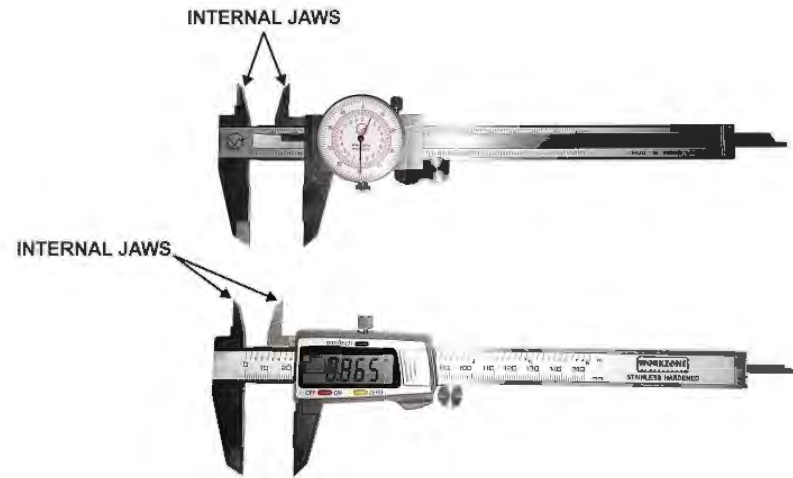

Figure 77: Internal Jaws of a Caliper

- b. Close the caliper completely and ensure that the caliper reads 0.000" (Figure 78). If the caliper does not read 0.000", consult the caliper manual for procedures to zero the caliper and zero the caliper before performing the inspection.



Figure 78: Reading a Dial Caliper

- c. Insert the inside measuring contacts or internal measuring jaws of the caliper (Figure 77) into the threaded opening of the BFA. Slowly open the caliper by using the adjusting roller until the contacts touch the threads of the BFA. The contacts should be centered in the diameter of the BFA (Figure 79).

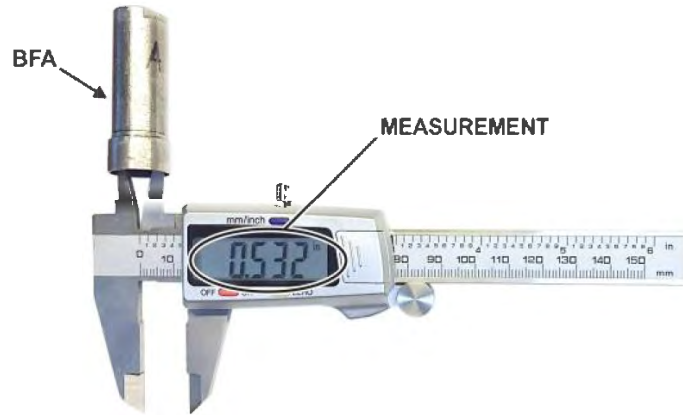

Figure 79: Diagram of Measurements

- d. Read the caliper measurement (Figure 80) and record this measurement.

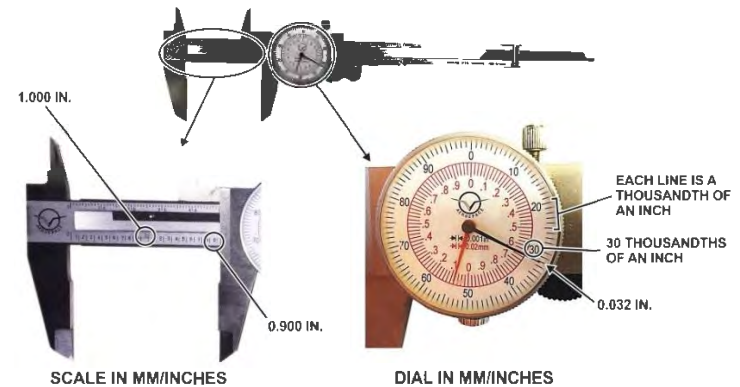

Figure 80: Reading Dial Caliper e.g. 1.932 inch

- e. Close the caliper and remove the contacts from the BFA opening.
- f. Rotate the BFA 90° and take another measurement 90° from the first measurement using the same method as the first (Figure 79).
- g. If the measurements taken are not between 0.5287" – 0.5333", the BFA should not be used and should be replaced with a serviceable BFA.

5.4.2 Barrel Thread Inspection

NOTE

The Barrel should be cleaned properly prior to conducting inspection.

- 6. In addition to inspecting the threads on the BFA, the threads on the rifle barrel need to be inspected.
 - a. Visually inspect the threads for wear and corrosion. If wear is found, the barrel should

not be used and should be replaced with a serviceable barrel.

If corrosion is found on the threads, the threads should be cleaned with a steel bristle brush, a clean rag and penetrating oil. Once clean, the threads should be inspected again for signs of damage from the corrosion, which include thread wear and pitting. If any damage is found, the rifle should not be used and CMP should be contacted for further inspection or replacement with a serviceable rifle.

- b. If the threads are visually acceptable, the profile of the threads should be inspected. For this inspection a 32 thread per inch profile gauge will be needed (Figure 81).



Figure 81: 32 inch Thread Profile Gauge

- i. Place the thread profile gauge on the threads at location A (Figure 82) on the barrel. Visually inspect the thread profile to ensure that the thread profile matches the profile of the gauge (Figure 83). If the profile does not match the profile of the gauge, the rifle should not

be used and CMP should be contacted for further inspection or replacement with a serviceable rifle. The barrel threads should follow and “sit” on the grooves of the thread profile gauge in order to be acceptable.

- ii. Repeat the inspection at locations B and C (Figure 82).

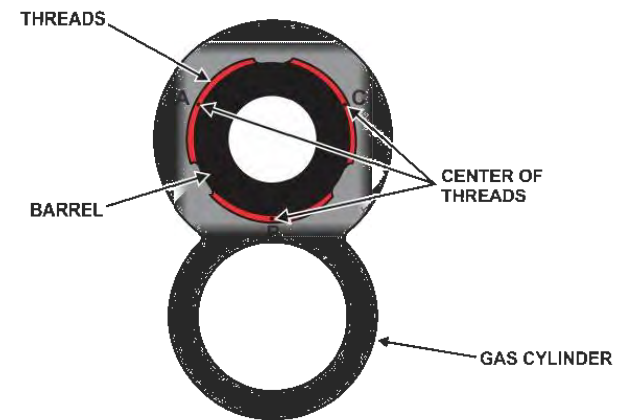

Figure 82: Thread Profile Inspection Points – View Looking at Muzzle

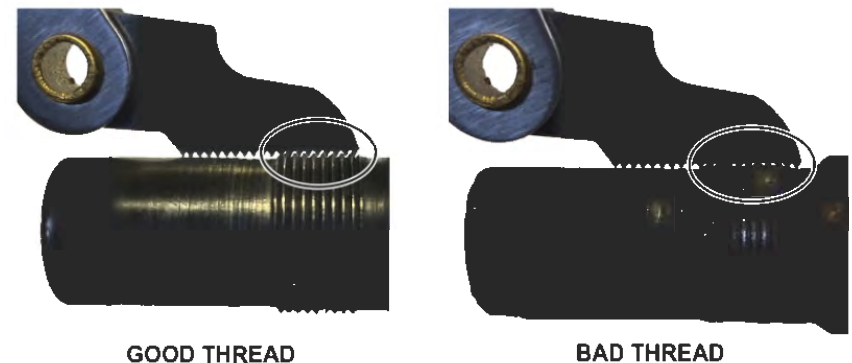

Figure 83: Thread Profile Inspection

c. If the thread profile is acceptable, the thread diameter of the barrel should be inspected. The diameter of the barrel threads should be $0.5614 - 0.0060/+0.0000$ inches. A standard dial caliper (Figure 75) or electronic caliper (Figure 76) with an accuracy of ± 0.001 " will be needed for this inspection.

- i. Close the caliper completely and ensure that the caliper reads 0.000" (Figure 78). If the caliper does not read 0.000", consult the caliper manual for procedures to zero the caliper and zero the caliper before performing the inspection.
- ii. Open the caliper and place barrel threads between the flat sections of the outside measuring contacts. The caliper should be positioned so that the barrel is protruding through the caliper contacts (Figure 84). Rotate the caliper around the barrel to take measurement A (Figure 85). Slowly close the caliper by using the adjusting roller until the contacts come into contact with the threads of the barrel. The contacts should be centered across the diameter of the barrel.

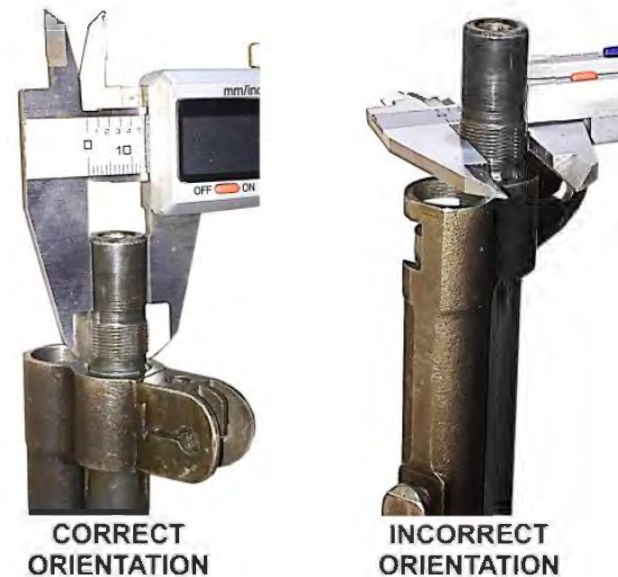

Figure 84: Barrel/ Caliper Orientation

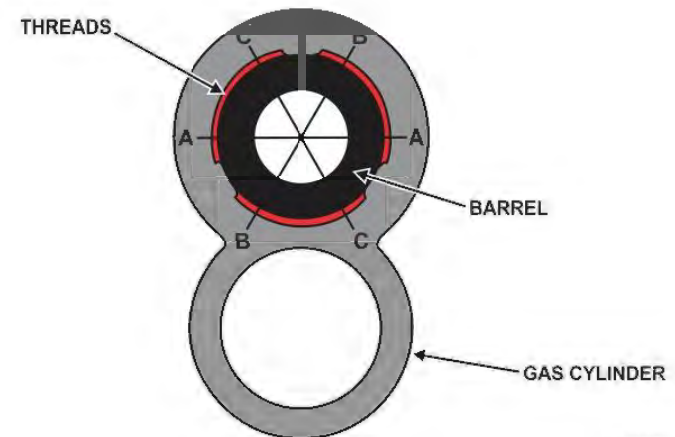

Figure 85: Barrel Thread Measurement Locations – View Looking at Muzzle

AR 35353

- iii. Read the caliper measurement (Figure 80) and record this measurement.
- iv. Open the caliper and rotate the caliper around the barrel to take measurement B (Figure 82) and take the measurement using the same method as the first and record the measurement.
- v. Open the caliper and rotate the caliper around the barrel to take measurement C (Figure 82) and take the measurement using the same method as the first and record the measurement.
- vi. If the measurements taken are not between 0.5554” – 0.5614”, the rifle should not be used and CMP should be contacted for further inspection or replacement with a serviceable rifle.

Reassembly

- 7. Once the inspections are completed, serviceable rifles and BFAs should be reassembled. Attach the **BFA** onto the **M1 Garand Barrel** until the **BFA** touches the **Gas Cylinder** (Figure 69).
- 8. Then install the **Gas Cylinder Lock Screw** onto the **Gas Cylinder** using a flat tip screw driver and firmly tighten using hand strength only.

6.0 Ceremony Planning and Safety Guidance

It is strongly recommended by the U.S. Combat Capabilities Development Command Armaments Center

that the following guidance and safety procedures be followed to the best of their ability by Veteran and Civilian Service Organizations, Law Enforcement, and National Cemetery Personnel while conducting ceremonies that require a firing salute or the rendering of “Funeral Honors”.

6.1 Ceremony Planning

It is strongly recommended that organizations familiarize themselves with the location of a ceremony that incorporates a firing salute and plan ahead as to where the firing party, firing party commander, spectators, Next of Kin (NOK), and any other involved organization will be located. A SAFETY AREA template is contained in Appendix A of this guide and can be copied and used in the field to facilitate the layout of a firing site.

General Guidance:

- 1) During familiarization, note should be taken of distances, structures, and vegetation that will assist the firing party in finding their position during the firing salute. (NOTE: Consideration toward the SAFETY AREA should be taken). Firing site considerations that will assist in identifying a firing position include but are not limited to: the location of the ceremony and attendees, the safety area required for a firing salute, control of spectators, terrain, and visual barriers (structural and vegetation).
- 2) The Firing Party should be on as level ground as possible.
- 3) The Firing Party should be in an open area large enough for the entire Firing Party.
- 4) The Firing Party should be in full view of the spectators, allowing minimal obstruction caused by vegetation.
- 5) It is recommended that if control of spectators will be a requirement, arrangements be made ahead of time to

facilitate this requirement with members of the Firing Party's own organization or associated organizations, such as local law enforcement.

- 6) The rifles being used should be inspected for serviceability.
 - a) Make sure the rifle is clear of ammunition.
 - b) Inspect the rifle for obvious signs of wear, damage, dirt, or debris.
 - c) To make sure the rifle is operating properly, pull the operating rod to its rearmost position; the bolt *SHOULD* stay open.
 - d) Close the bolt and snap the safety to its locked position. Squeeze the trigger; the hammer *SHOULD NOT* fall.
 - e) Push the safety to its unlocked position and squeeze the trigger; the hammer *SHOULD* fall.
 - f) During this inspection the bolt should move freely.

6.2 Hearing Protection

It is strongly recommended, to reduce the potential for hearing injury, that all personnel involved in the firing party, the individuals in the firing party as well as the firing party commander, don commercially available hearing protection, with a noise reduction rating (NRR) of 33, prior to conducting any ceremony that incorporates a firing salute or the rendering of "Funeral Honors".

6.3 Standoff Distance

To provide adequate safety for spectators or NOK during firing salutes, it is strongly recommended that an appropriate standoff distance between the firing party and any spectators/NOK be used while conducting these ceremonies. It is recommended that for ceremonies requiring a firing salute, organizations use the SAFETY AREA template in Appendix A of this guide. It is

recommended that organizations use this SAFETY AREA to the greatest extent possible while making allowances for terrain variation, structures, and the position of spectators and/or NOK.

6.4 Expended Brass

The potential exists for either a misfired round or live round to be ejected from a rifle during a Firing Salute/Rendering of "Funeral Honors" and that newly expended cartridge cases can represent either a burn hazard or have sharp edges and present a cutting hazard. It is recommended that spectators and/or NOK be instructed to **NOT** retrieve brass after a firing salute has been conducted and that the expended cartridge cases will be retrieved by personnel from the organization conducting the Firing Salute/Rendering of "Funeral Honors". If it is part of the organization's standard operating procedure to distribute cartridge cases to either spectators or NOK after a firing salute, it is recommended that the cartridge cases be inspected by organization personnel prior to distribution to make sure they are free of hazards.

7.0 Ammunition

7.1 Ammunition Safety Warnings

DO NOT FIRE SERIOUSLY CORRODED AMMUNITION OR DENTED CARTRIDGES

DO NOT FIRE BLANK AMMUNITION TOWARD PERSONNEL WITHIN THE STANDOFF DISTANCE (40 METERS)

DO NOT LUBRICATE AMMUNITION UNDER ANY CIRCUMSTANCES

ONLY .30 CALIBER M1909 BLANK AMMUNITION
OBTAINED FROM THE JOINT MUNITIONS
COMMAND IS AUTHORIZED TO BE FIRED THROUGH
THE M1 GARAND RIFLE

IF AMMUNITION IS WET OR DIRTY, WIPE IT OFF
WITH A RAG PRIOR TO USE; DUST AND OTHER
ABRASIVES THAT COLLECT ON OILY AMMUNITION
ARE DAMAGING TO OPERATING PARTS OF THE GUN

DO NOT FIRE THE M3 GRENADE CARTRIDGE

7.2 Ordering Ammunition

- 1) Only authorized organizations that have been issued weapons through the Ceremonial Rifle Program managed by the U.S. Army Tank-Automotive and Armaments Command (TACOM) located in Detroit Arsenal, MI, are authorized to order and receive blank ammunition or ammunition clips.
- 2) The request to order .30 Caliber blank ammunition and clips can be sent either by letter, e-mail, or phone call –NOTE: A new form needs to be requested each time an organization needs to order blank ammunition or clips. For authorized civilian and veterans organizations, forms (as well as the ammunition shipment itself) are sent to the appropriate officer's/individual's residential address and not the organization. For Law Enforcement and Public Safety related organizations, the forms (and ammunition shipments) are sent to the organization.
- 3) The request for issue of ammunition should be directed to:

U.S. Army Joint Munitions
Command Attn: AMSJM-MLD
2695 Rodman Ave
Rock Island, IL 61299-6000

Point of Contact: Dawn Folland
E-mail: Dawn.L.Folland.civ@mail.mil
TOLL FREE: 877-233-2515 or Commercial 309-782-4608

- 4) Quantity ordered is limited to 2 boxes or 2,480 rounds. Ammunition is packed 1,240 rounds in 2 metal ammunition containers over-packed inside a wooden box.
- 5) **No payments are required. Ammunition and Clips are provided free of charge to authorized organizations (Shipping and Handling fees are not required).**
- 6) Organizations will be notified by letter of the approximate shipment date of the ammunition/clip order. Allow 6-8 weeks for delivery after Rock Island receives and processes your order.
- 7) All ammunition is shipped via Federal Express (FEDEX) from the Lake City Army Ammunition Plant, Independence, MO. Normal FEDEX delivery will be Monday through Friday between 9:00AM and 5:00PM. A signature will be required upon receipt.

7.3 Authorized Ammunition

The current design of the .30 caliber blank cartridge incorporates a rosette crimp mouth closure. The bottle nose closure design of the .30 caliber blank cartridge is still approved for use and should be considered serviceable. See figure 86 for authorized ammunition.

WARNING: Make sure you NEVER fire any ammunition other than the supplied blanks in your rifle. Firing unauthorized ammunition may result in severe injury to yourself and others nearby, or damage to the weapon.

If an organization's ammunition source is unknown, that ammunition should be inspected for the presence of the .30 caliber M3 grenade cartridges. The grenade cartridge generates more pressure than the M1909 .30 caliber blank cartridge and is not designed or intended to be fired with a blank firing adapter. The significant physical difference between the grenade cartridge and the blank cartridge is that the blank cartridge has 6 crimps and the grenade cartridge has 5 crimps (See figs 87 and 88).

NOTE: If the rosette crimp of the blank cartridge does not open during normal firing and cycling it should not be considered a malfunction.



Figure 86. Authorized ammunition – rosette crimp (left) and bottle nose (right)



Figure 87. Grenade Cartridge vs. Blank Cartridge



Figure 88. Grenade Cartridge vs. Blank Cartridge

8.0 Physical Security and Inventory Requirements

8.1 Rifle and Ammunition – Physical Security and Inventory Requirement

- 1) The physical security for the U.S. Army rifles conditionally assigned to qualified civilian organizations is at the customer's discretion. However, each organization is required to comply with local, state, and federal guidelines. Currently, a customer is required to complete a Certificate of Arms Storage form as a condition of the qualification process. This form can be found on the following website:

<https://www.tacom.army.mil/ilsc/donations/>

- 2) Additionally, each organization assigned U.S. Army rifles for ceremonial use are required to report their inventory every three years to the Army Donations Program Office (The form can be found in Appendix B). If a weapon is discovered missing for any reason, the organization is supposed to report the missing asset to their local law enforcement agency and to the Army Donations Program Office within 24 hours of discovery.
- 3) Coordination with JMC is applicable to the customer request for blank ammunition. JMC contacts the Army Donations Program Office to ensure the customer received rifles through the Army Ceremonial Rifle Program before sending the blank ammunition eligibility paperwork.

- 4) Any questions associated with physical security and inventory requirements should be directed to the Army Donations Program:

U.S. Army TACOM Life Cycle Management Command
ATTN: Army Donations Program, MS: 419D
6501 East 11 Mile Road
Detroit Arsenal, MI 48397-5000

Point of Contact:

E-mail: usarmy.detroit.tacom.mbx.ilsc-donations@mail.mil
Phone: (586)-282-9861

9.0 Comments, Questions, and Suggestions

Comments, questions, or suggestions with regard to this maintenance guide should be forwarded to the following:

U.S. Army
Combat Capabilities Development Command,
Armaments Center Attn: FCDD-ACE-LL
Picatinny Arsenal NJ, 07806-5000

Point of Contact:

Telephone: 973-724-3056 Fax: 973-724-4633
E-mail: usarmy.ccdc-ac.pica2028@mail.mil

Additional information on the operation, safety, and maintenance of the M1 Garand rifle and the M1909 .30 caliber blank cartridge, as well as an electronic version of this guide, can be found at the following website:

<http://www.m1garandtraining.com>

Visit the website to ensure you have the latest information.

Appendix A: SAFETY AREA TEMPLATE

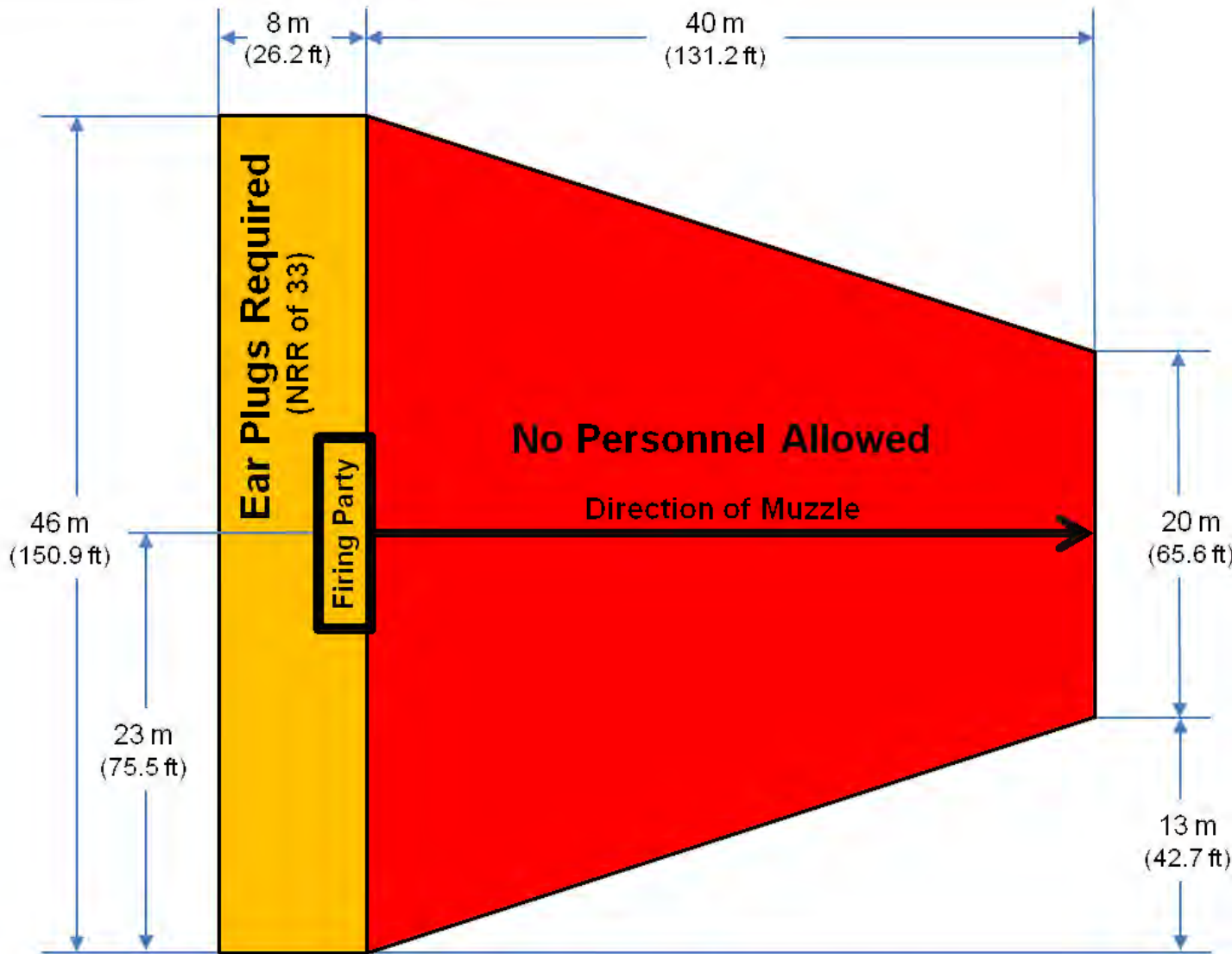

Note: Personnel outside of the Safety Area do not need hearing protection

Ceremonial Rifle Inventory Form

SECTION I – ORGANIZATION INFORMATION

1. Organization Name:	3. State:
2. City:	

SECTION II – STATUS OF US ARMY OWNED CEREMONIAL RIFLES ISSUED TO ORGANIZATION

In accordance with the Conditional Deed of Gift(s), AR 700-131 and Title 10 USC §7683, I hereby certify that the following United States Army owned rifles conditionally issued for ceremonial use to the above organization are:

- still required and used in the manner agreed upon in the original statement.
- require replacement (place an asterisk (*) next to every rifle that requires replacement).
- no longer required. Request the ceremonial rifle team provide disposition instructions to return ceremonial rifles.
- Our organization does not have any ceremonial rifles on hand.

SECTION III – RIFLE LISTING

	Model:	Manufacturer:	Serial Number:
1.			
2.			
3.			
4.			
5.			
6.			
7.			
8.			
9.			
10.			
11.			
12.			

Ceremonial Rifle Inventory Form

SECTION III – RIFLE LISTING (CONTINUED)

13.	Model:	Manufacturer:	Serial Number:
14.	Model:	Manufacturer:	Serial Number:
15.	Model:	Manufacturer:	Serial Number:
16.	Model:	Manufacturer:	Serial Number:
17.	Model:	Manufacturer:	Serial Number:
18.	Model:	Manufacturer:	Serial Number:
19.	Model:	Manufacturer:	Serial Number:
20.	Model:	Manufacturer:	Serial Number:

If you have additional weapons, list them on a separate piece of paper and attach to this form.

SECTION IV – ACKNOWLEDGEMENT

By signing below, I hereby certify that to the best of my knowledge and belief that a 100% inventory of all Ceremonial Rifles in our possession was performed and that the rifles listed above (and on attachments) are the only rifles in the possession of this organization at this time and that all of my statements are true, correct, complete and made in good faith. I understand and acknowledge that concealing material fact and/or making a false statement is a violation of Title 18 USC §1001 and may result in the cancellation of the Conditional Deed for any US Army property on loan to my organization and is punishable by fine or imprisonment. Furthermore, if any additional rifles are located we will notify the US Army within 30 days of their discovery.

1. Signature of Highest Ranking Official:	2. Date Signed:
3. Printed Name of Person Signing (First, Middle Initial, Last):	
4. Organization Telephone Number:	5. Organization Email Address:

SECTION V – NOTARY ENDORSEMENT

1. Official Notary Signature:	2. Notary Seal/Stamp:
-------------------------------	-----------------------

Mail to: US Army Tank-Automotive and Armaments Command, ATTN: AMTA-LCL-IFD, M/S 419D, 6501 East 11 Mile Road, Detroit Arsenal, MI 48397-5000